

Alienware 15 Service Manual

Computer Model: Alienware 15 R2
Regulatory Model: P42F
Regulatory Type: P42F002

ALIENWARE 

Notes, cautions, and warnings

 **NOTE:** A NOTE indicates important information that helps you make better use of your computer.

 **CAUTION:** A CAUTION indicates either potential damage to hardware or loss of data and tells you how to avoid the problem.

 **WARNING:** A WARNING indicates a potential for property damage, personal injury, or death.

Copyright © 2015 Dell Inc. All rights reserved. This product is protected by U.S. and international copyright and intellectual property laws. Dell™ and the Dell logo are trademarks of Dell Inc. in the United States and/or other jurisdictions. All other marks and names mentioned herein may be trademarks of their respective companies.

2015 - 09

Rev. A00

Contents

Before working inside your computer.....	12
Before you begin	12
Safety instructions.....	12
Recommended tools.....	13
After working inside your computer.....	14
Removing the base panel.....	15
Procedure.....	15
Replacing the base panel.....	18
Procedure.....	18
Removing the memory modules.....	19
Prerequisites.....	19
Procedure.....	19
Replacing the memory modules.....	21
Procedure.....	21
Post-requisites.....	22
Removing the solid-state drives.....	23
Prerequisites.....	23
Procedure.....	23
Replacing the solid-state drives.....	25
Procedure.....	25
Post-requisites.....	25

Removing the hard drive.....	26
Prerequisites.....	26
Procedure.....	27
Replacing the hard drive.....	31
Procedure.....	31
Post-requisites.....	31
Removing the wireless card.....	32
Prerequisites.....	32
Procedure.....	32
Replacing the wireless card.....	34
Procedure.....	34
Post-requisites.....	35
Removing the palm rest.....	36
Prerequisites.....	36
Procedure.....	36
Replacing the palm rest.....	43
Procedure.....	43
Post-requisites.....	43
Removing the touch pad.....	44
Prerequisites.....	44
Procedure.....	44
Replacing the touch pad.....	48
Procedure.....	48
Post-requisites.....	48

Removing the keyboard.....	49
Prerequisites.....	49
Procedure.....	49
Replacing the keyboard.....	55
Procedure.....	55
Post-requisites.....	55
Removing the power-button board.....	56
Prerequisites.....	56
Procedure.....	56
Replacing the power-button board.....	59
Procedure.....	59
Post-requisites.....	59
Removing the status-light board.....	60
Prerequisites.....	60
Procedure.....	61
Replacing the status-light board.....	63
Procedure.....	63
Post-requisites.....	63
Removing the I/O board.....	64
Prerequisites.....	64
Procedure.....	64
Replacing the I/O board.....	66
Procedure.....	66
Post-requisites.....	66

Removing the speakers.....	67
Prerequisites.....	67
Procedure.....	67
Replacing the speakers.....	70
Procedure.....	70
Post-requisites.....	70
Removing the front AlienFX LED boards.....	71
Prerequisites.....	71
Procedure.....	71
Replacing the front AlienFX LED board.....	73
Procedure.....	73
Post-requisites.....	73
Removing the hinge covers.....	74
Prerequisites.....	74
Procedure.....	74
Replacing the hinge covers.....	76
Procedure.....	76
Post-requisites.....	76
Removing the display assembly.....	77
Prerequisites.....	77
Procedure.....	77
Replacing the display assembly.....	81
Procedure.....	81
Post-requisites.....	81

Removing the display bezel.....	83
Prerequisites.....	83
Procedure.....	83
Replacing the display bezel.....	87
Procedure.....	87
Post-requisites.....	87
Removing the display panel.....	88
Prerequisites.....	88
Procedure.....	88
Replacing the display panel.....	91
Procedure.....	91
Post-requisites.....	91
Removing the display hinges.....	92
Prerequisites.....	92
Procedure.....	92
Replacing the display hinges.....	94
Procedure.....	94
Post-requisites.....	94
Removing the camera.....	95
Prerequisites.....	95
Procedure.....	96
Replacing the camera.....	98
Procedure.....	98
Post-requisites.....	98

Removing the display back-cover.....	99
Prerequisites.....	99
Procedure.....	99
Replacing the display back-cover.....	102
Procedure.....	102
Post-requisites.....	102
Removing the Alienware AlienHead LED board..	103
Prerequisites.....	103
Procedure.....	103
Replacing the Alienware AlienHead LED board..	106
Procedure.....	106
Post-requisites.....	106
Removing the display-panel AlienFX LEDs.....	107
Prerequisites.....	107
Procedure.....	108
Replacing the display-panel AlienFX LEDs.....	110
Procedure.....	110
Post-requisites.....	110
Removing the logo board.....	111
Prerequisites.....	111
Procedure.....	111
Replacing the logo board.....	113
Procedure.....	113
Post-requisites.....	113

Removing the system board.....	114
Prerequisites.....	114
Procedure.....	114
Replacing the system board.....	118
Procedure.....	118
Post-requisites.....	119
Entering the Service Tag in the BIOS setup program.....	119
Removing the heat-sink assembly.....	120
Prerequisites.....	120
Procedure.....	120
Replacing the heat-sink assembly.....	122
Procedure.....	122
Post-requisites.....	122
Removing the fans.....	123
Prerequisites.....	123
Procedure.....	123
Replacing the fans.....	125
Procedure.....	125
Post-requisites.....	125
Removing the power-adaptor port.....	126
Prerequisites.....	126
Procedure.....	126
Replacing the power-adaptor port.....	128
Procedure.....	128
Post-requisites.....	128



Removing the coin-cell battery.....	129
Prerequisites.....	129
Procedure.....	129
Replacing the coin-cell battery.....	131
Procedure.....	131
Post-requisites.....	131
Removing the battery.....	132
Prerequisites.....	132
Procedure.....	132
Replacing the battery.....	135
Procedure.....	135
Post-requisites.....	135
Removing the computer base.....	136
Prerequisites.....	136
Procedure.....	136
Replacing the computer base.....	138
Procedure.....	138
Post-requisites.....	138
BIOS setup program.....	139
Overview.....	139
BIOS setup program options.....	139
Boot sequence.....	143
Boot options.....	143
Changing boot sequence for the current boot.....	144
Changing boot sequence for future boots.....	144
Flashing the BIOS.....	146

Getting help and contacting Alienware.....	147
Self-help resources.....	147
Contacting Alienware.....	147

Before working inside your computer

 **NOTE:** The images in this document may differ from your computer depending on the configuration you ordered.

Before you begin

- 1 Save and close all open files and exit all open applications.
- 2 Shut down your computer.
 - Windows 10: Click or tap **Start** →  **Power** → **Shut down**.
 - Windows 8.1: On the **Start** screen, click or tap the power icon  → **Shut down**.
 - Windows 7: Click or tap **Start** → **Shut down**.

 **NOTE:** If you are using a different operating system, see the documentation of your operating system for shut-down instructions.

- 3 Disconnect your computer and all attached devices from their electrical outlets.
- 4 Disconnect all cables such as telephone cables, network cables and so on, from your computer.
- 5 Disconnect all attached devices and peripherals, such as keyboard, mouse, monitor, and so on, from your computer.
- 6 Remove any media card and optical disc from your computer, if applicable.

Safety instructions

Use the following safety guidelines to protect your computer from potential damage and ensure your personal safety.

 **WARNING:** Before working inside your computer, read the safety information that shipped with your computer. For more safety best practices, see the Regulatory Compliance home page at www.dell.com/regulatory_compliance.

 **WARNING:** Disconnect all power sources before opening the computer cover or panels. After you finish working inside the computer, replace all covers, panels, and screws before connecting to the power source.

 **CAUTION:** To avoid damaging the computer, ensure that the work surface is flat and clean.

 **CAUTION:** To avoid damaging the components and cards, handle them by their edges and avoid touching pins and contacts.

 **CAUTION:** You should only perform troubleshooting and repairs as authorized or directed by the Dell technical assistance team. Damage due to servicing that is not authorized by Dell is not covered by your warranty. See the safety instructions that shipped with the product or at www.dell.com/regulatory_compliance.

 **CAUTION:** Before touching anything inside your computer, ground yourself by touching an unpainted metal surface, such as the metal at the back of the computer. While you work, periodically touch an unpainted metal surface to dissipate static electricity, which could harm internal components.

 **CAUTION:** When you disconnect a cable, pull on its connector or on its pull tab, not on the cable itself. Some cables have connectors with locking tabs or thumb-screws that you must disengage before disconnecting the cable. When disconnecting cables, keep them evenly aligned to avoid bending any connector pins. When connecting cables, ensure that the ports and connectors are correctly oriented and aligned.

 **CAUTION:** Press and eject any installed card from the media-card reader.

Recommended tools

The procedures in this document may require the following tools:

- Phillips screwdriver
- Plastic scribe

After working inside your computer

 **CAUTION: Leaving stray or loose screws inside your computer may severely damage your computer.**

- 1** Replace all screws and ensure that no stray screws remain inside your computer.
- 2** Connect any external devices, peripherals, and cables you removed before working on your computer.
- 3** Replace any media cards, discs, and any other parts that you removed before working on your computer.
- 4** Connect your computer and all attached devices to their electrical outlets.
- 5** Turn on your computer.

Removing the base panel



WARNING: Before working inside your computer, read the safety information that shipped with your computer and follow the steps in [Before working inside your computer](#). After working inside your computer, follow the instructions in [After working inside your computer](#). For more safety best practices, see the Regulatory Compliance home page at www.dell.com/regulatory_compliance.

Procedure

- 1 Close the display and turn the computer over.
- 2 Loosen the captive screws that secure the base panel to the computer base.
- 3 Using a plastic scribe, gently release the tabs that secure the base panel to the computer base.

4 Slide and remove the base panel from the computer base.

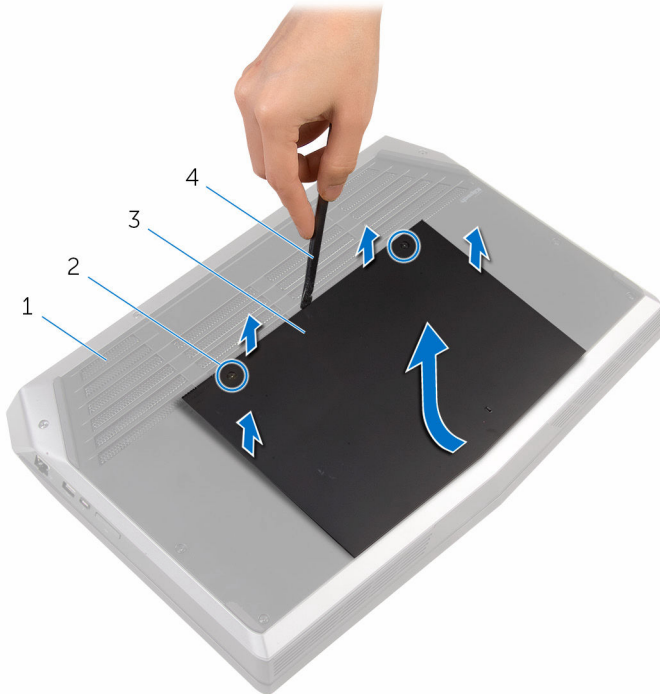

1 computer base

2 captive screws (2)

3 base panel

4 plastic scribe

- 5 Disconnect the battery cable from the system board.

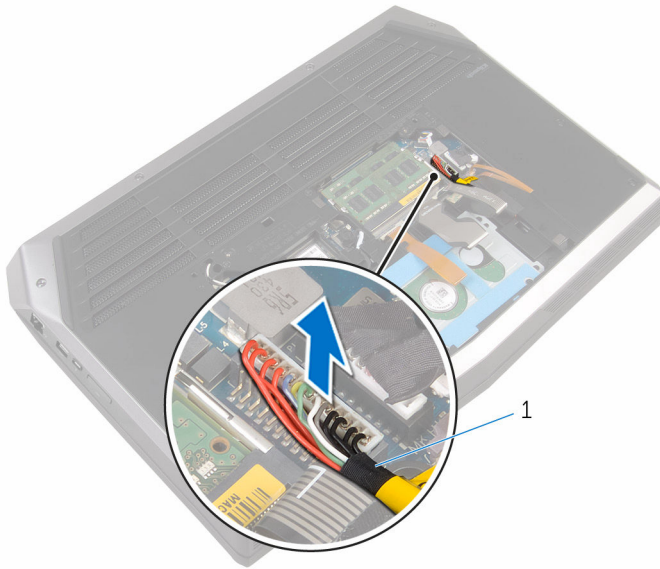

1 battery cable

- 6 Turn the computer over and open the display as far as possible.
- 7 Press and hold the power button for 4 seconds to ground the system board.

Replacing the base panel



WARNING: Before working inside your computer, read the safety information that shipped with your computer and follow the steps in [Before working inside your computer](#). After working inside your computer, follow the instructions in [After working inside your computer](#). For more safety best practices, see the Regulatory Compliance home page at www.dell.com/regulatory_compliance.

Procedure

- 1 Close the display and turn the computer over.
- 2 Connect the battery cable to the system board.
- 3 Slide the tabs on the base panel into the slots on the computer base and snap the base panel into place.
- 4 Tighten the captive screws that secure the base panel to the computer base.

Removing the memory modules



WARNING: Before working inside your computer, read the safety information that shipped with your computer and follow the steps in [Before working inside your computer](#). After working inside your computer, follow the instructions in [After working inside your computer](#). For more safety best practices, see the Regulatory Compliance home page at www.dell.com/regulatory_compliance.

Prerequisites

Remove the [base panel](#).

Procedure

- 1 Using your fingertips, carefully spread apart the securing clips on each end of the memory-module slot until the memory module pops up.

2 Slide and remove the memory module from the memory-module slot.

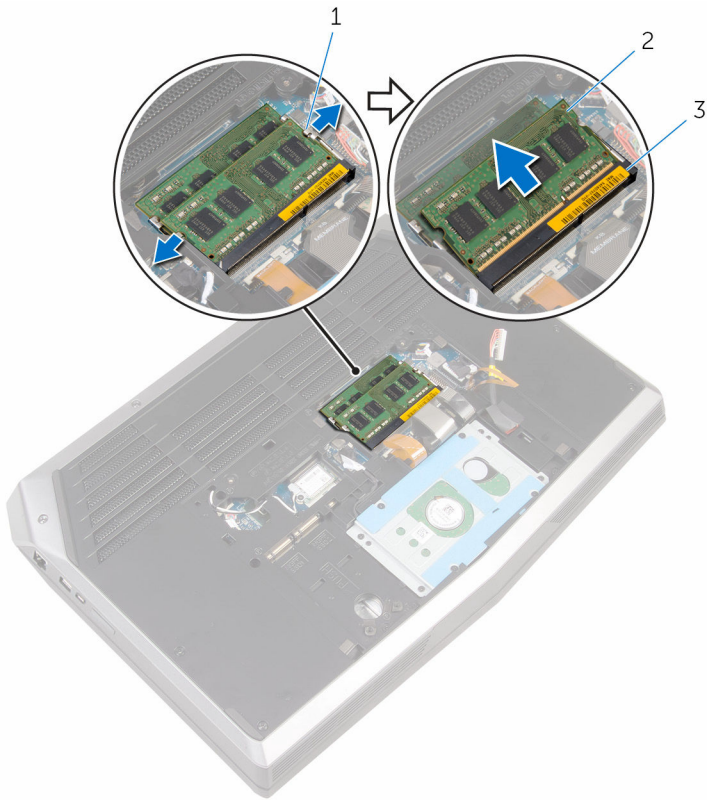

1 securing clips (2)

2 memory modules (2)

3 memory-module slot

Replacing the memory modules



WARNING: Before working inside your computer, read the safety information that shipped with your computer and follow the steps in [Before working inside your computer](#). After working inside your computer, follow the instructions in [After working inside your computer](#). For more safety best practices, see the Regulatory Compliance home page at www.dell.com/regulatory_compliance.

Procedure

- 1 Align the notch on the memory module with the tab on the memory-module slot.

- 2 Slide the memory module firmly into the slot at an angle and press the memory module down until it clicks into place.

 **NOTE:** If you do not hear the click, remove the memory module and reinstall it.

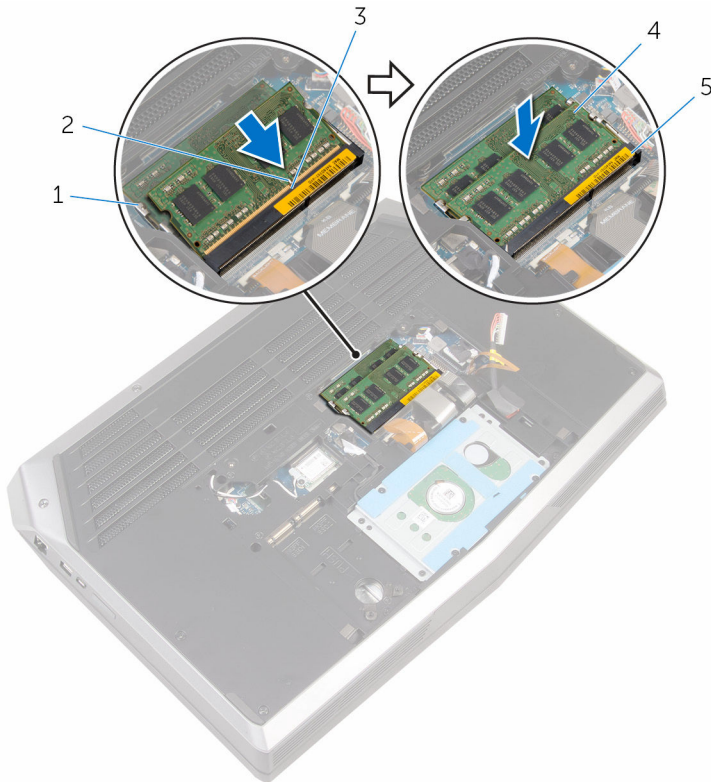

1 securing clips (2)

2 notch

3 tab



4 memory modules (2)

5 memory-module slot

Post-requisites

Replace the [base panel](#).

Removing the solid-state drives

-  **WARNING:** Before working inside your computer, read the safety information that shipped with your computer and follow the steps in [Before working inside your computer](#). After working inside your computer, follow the instructions in [After working inside your computer](#). For more safety best practices, see the Regulatory Compliance home page at www.dell.com/regulatory_compliance.
-  **CAUTION:** Solid-state drives are fragile. Exercise care when handling the hard drive.
-  **CAUTION:** To avoid data loss, do not remove the solid-state drive while the computer is in sleep or on state.

Prerequisites

Remove the [base panel](#).

Procedure

- 1 Remove the screw that secures the solid-state drive to the computer base.

2 Slide and remove the solid-state drive from the solid-state drive slot.

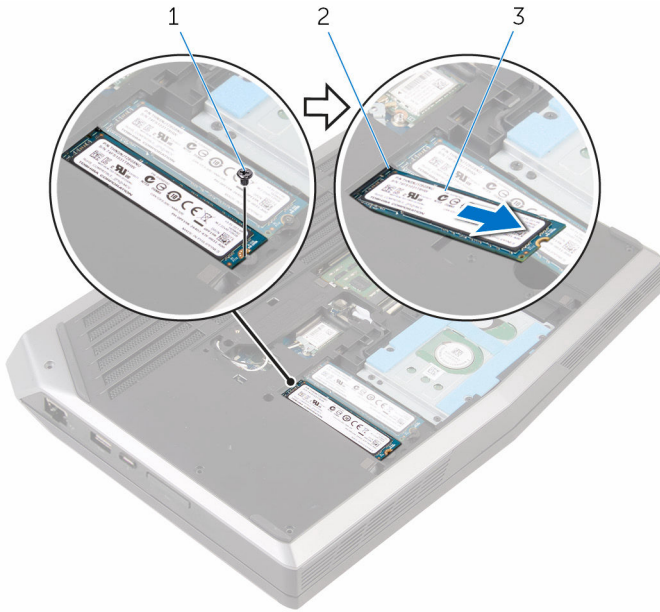

1 screw

2 solid-state drive slot

3 solid-state drives (2)

Replacing the solid-state drives

 **WARNING:** Before working inside your computer, read the safety information that shipped with your computer and follow the steps in [Before working inside your computer](#). After working inside your computer, follow the instructions in [After working inside your computer](#). For more safety best practices, see the Regulatory Compliance home page at www.dell.com/regulatory_compliance.

 **CAUTION:** Solid-state drives are fragile. Exercise care when handling the hard drive.

Procedure

- 1 Slide the solid-state drive into the solid-state drive slot.
- 2 Align the screw hole on the solid-state drive with the screw hole on the computer base.
- 3 Replace the screw that secures the solid-state drive to the computer base.

Post-requisites

Replace the [base panel](#).

Removing the hard drive

 **WARNING:** Before working inside your computer, read the safety information that shipped with your computer and follow the steps in [Before working inside your computer](#). After working inside your computer, follow the instructions in [After working inside your computer](#). For more safety best practices, see the Regulatory Compliance home page at www.dell.com/regulatory_compliance.

 **CAUTION:** Hard drives are fragile. Exercise care when handling the hard drive.

 **CAUTION:** To avoid data loss, do not remove the hard drive while the computer is in sleep or on state.

Prerequisites

Remove the [base panel](#).

Procedure

- 1 Remove the keyboard-backlight cable, keyboard cable, and macro-keys cable from the routing guides on the computer base.

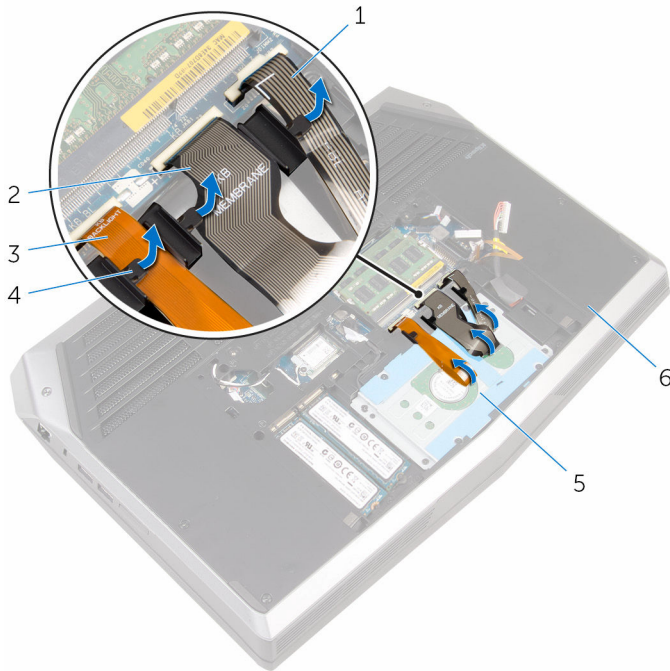

- | | | | |
|---|--------------------------|---|--------------------|
| 1 | macro-keys cable | 2 | keyboard cable |
| 3 | keyboard-backlight cable | 4 | routing guides (3) |
| 5 | hard-drive assembly | 6 | computer base |

- 2 Remove the screws that secure the hard-drive assembly to the computer base.
- 3 Using the pull tab, disconnect the hard-drive cable from the system board.
- 4 Note the hard-drive cable routing and remove the cable from the routing guides on the computer base.

5 Lift and slide the hard-drive assembly off the computer base.

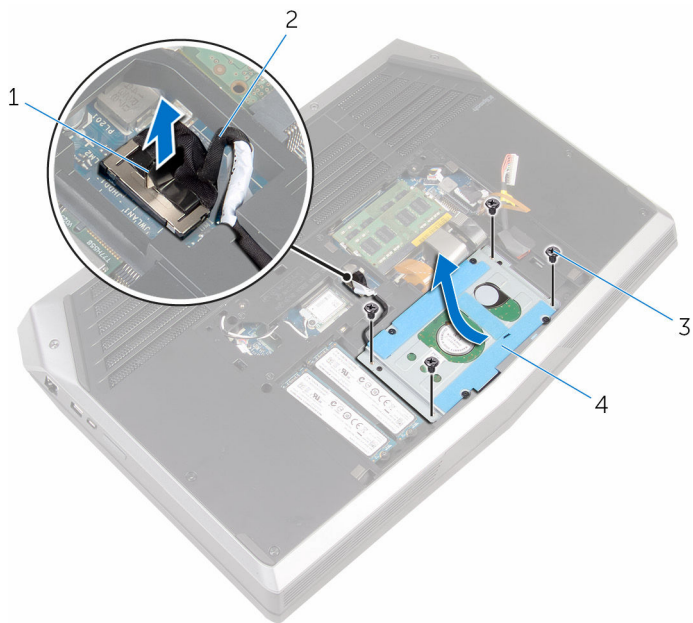

1 pull tab

2 hard-drive cable

3 screws (4)

4 hard-drive assembly

6 Remove the screws that secure the hard-drive bracket to the hard-drive assembly.

7 Lift the hard-drive bracket off the hard-drive assembly.

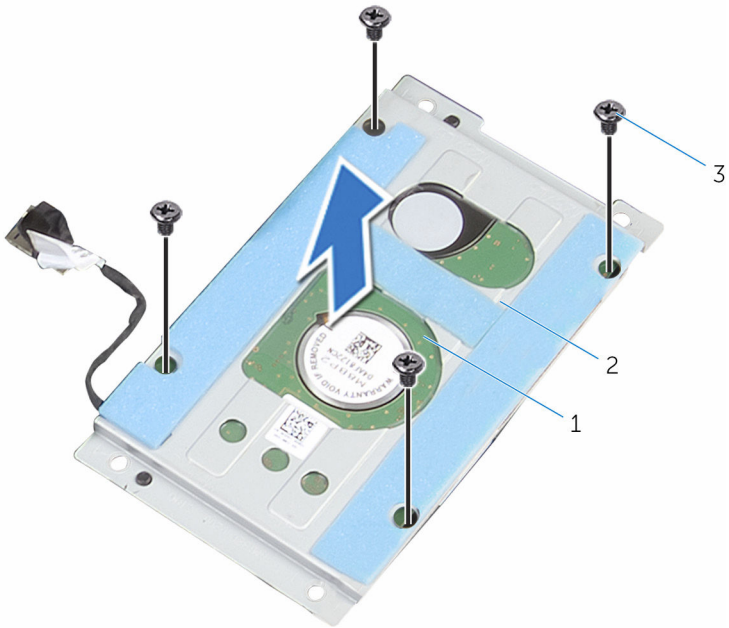

1 hard-drive assembly

2 hard-drive bracket

3 screws (4)

8 Disconnect the interposer from the hard drive.

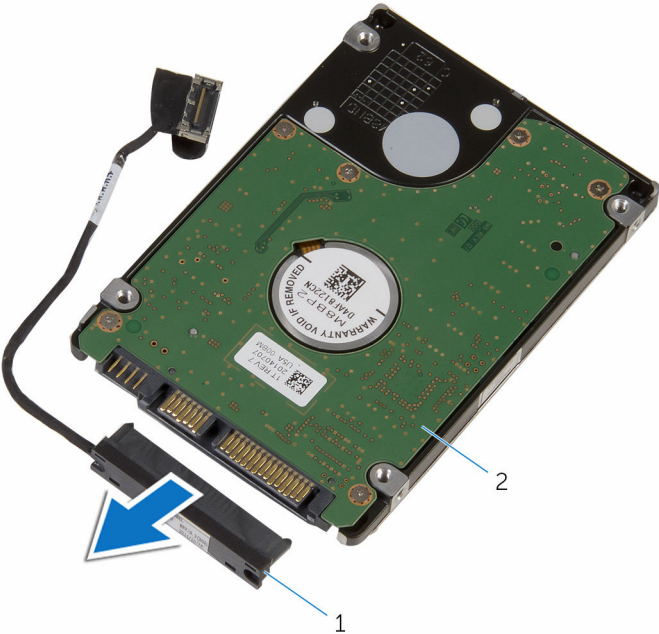

1 interposer

2 hard drive

Replacing the hard drive

 **WARNING:** Before working inside your computer, read the safety information that shipped with your computer and follow the steps in [Before working inside your computer](#). After working inside your computer, follow the instructions in [After working inside your computer](#). For more safety best practices, see the Regulatory Compliance home page at www.dell.com/regulatory_compliance.

 **CAUTION:** Hard drives are fragile. Exercise care when handling the hard drive.

Procedure

- 1 Connect the interposer to the hard drive.
- 2 Align the screw holes on the hard-drive bracket with the screw holes on the hard-drive assembly.
- 3 Replace the screws that secure the hard-drive bracket to the hard-drive assembly.
- 4 Slide the hard-drive assembly under the tab on the computer base and align the screw holes on the hard-drive assembly with the screw holes on the computer base.
- 5 Replace the screws that secure the hard-drive assembly to the computer base.
- 6 Route the hard-drive cable through the routing guides on the computer base.
- 7 Connect the hard-drive cable to the system board.
- 8 Route the keyboard-backlight cable, keyboard cable, and macro-keys cable through the routing guides on the computer base.

Post-requisites

Replace the [base panel](#).

Removing the wireless card



WARNING: Before working inside your computer, read the safety information that shipped with your computer and follow the steps in [Before working inside your computer](#). After working inside your computer, follow the instructions in [After working inside your computer](#). For more safety best practices, see the Regulatory Compliance home page at www.dell.com/regulatory_compliance.

Prerequisites

Remove the [base panel](#).

Procedure

- 1 Remove the screw that secures the wireless-card bracket to the system board.
- 2 Lift the wireless-card bracket off the wireless card.
- 3 Disconnect the antenna cables from the wireless card.

4 Lift and slide the wireless card out of the wireless-card slot.

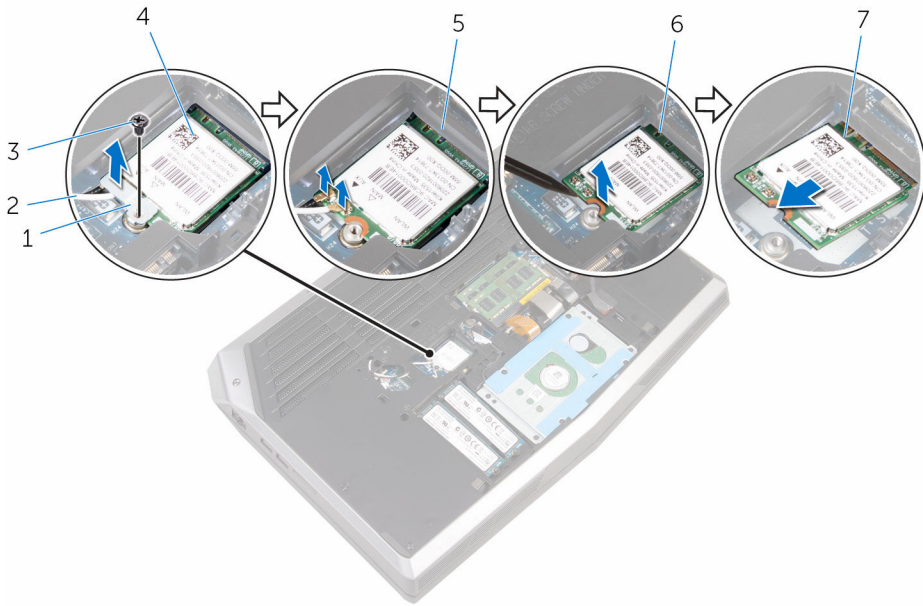

1 wireless-card bracket

3 screw

5 wireless-card slot

7 notches (2)

2 antenna cables (2)

4 wireless card

6 tabs (2)

Replacing the wireless card

 **WARNING:** Before working inside your computer, read the safety information that shipped with your computer and follow the steps in [Before working inside your computer](#). After working inside your computer, follow the instructions in [After working inside your computer](#). For more safety best practices, see the Regulatory Compliance home page at www.dell.com/regulatory_compliance.

Procedure

 **CAUTION:** To avoid damaging the wireless card, do not place any cables under it.

- 1 Align the notches on the wireless card with the tabs on the wireless-card slot.
- 2 Slide the wireless-card at an angle into the wireless-card slot.
- 3 Connect the antenna cables to the wireless card.

A label at the tip of the antenna cables indicates color scheme for the wireless card supported by your computer.

Connectors on the wireless card	Antenna-cable sticker color
Main (white triangle)	White
Auxiliary (black triangle)	Black

- 4 Press the other end of the wireless card down and align the screw hole on the wireless-card bracket with the screw hole on the system board.

- 5 Replace the screw that secures the wireless-card bracket to the system board.

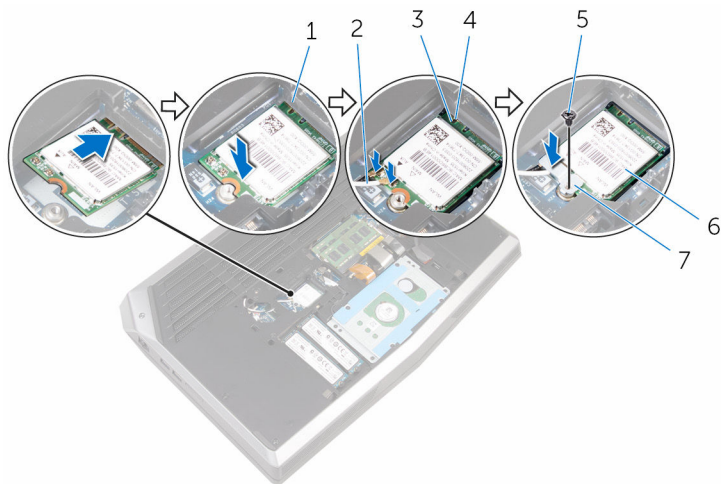

- | | | | |
|---|-----------------------|---|--------------------|
| 1 | wireless-card slot | 2 | antenna cables (2) |
| 3 | notches (2) | 4 | tabs (2) |
| 5 | screw | 6 | wireless card |
| 7 | wireless-card bracket | | |

Post-requisites

Replace the [base panel](#).

Removing the palm rest



WARNING: Before working inside your computer, read the safety information that shipped with your computer and follow the steps in [Before working inside your computer](#). After working inside your computer, follow the instructions in [After working inside your computer](#). For more safety best practices, see the Regulatory Compliance home page at www.dell.com/regulatory_compliance.

Prerequisites

- 1 Remove the [base panel](#).
- 2 Remove the [memory modules](#).
- 3 Remove the [solid-state drives](#).

Procedure

- 1 Remove the keyboard cable, keyboard-backlight cable, and macro-keys cable from the routing guides on the computer base.

- 2** Lift the latches and disconnect the keyboard-backlight cable, keyboard cable, macro-keys cable, and macro-keys backlight cable from the system board.

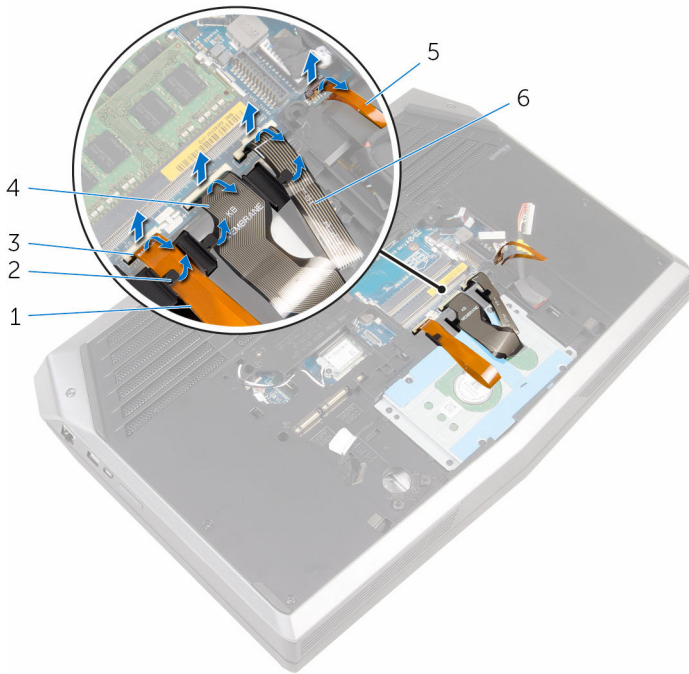

- | | | | |
|---|----------------------------|---|--------------------|
| 1 | keyboard-backlight cable | 2 | routing guides (3) |
| 3 | latches (4) | 4 | keyboard cable |
| 5 | macro-keys backlight cable | 6 | macro-keys cable |

- 3** Remove the screws that secure the palm-rest assembly to the computer base.

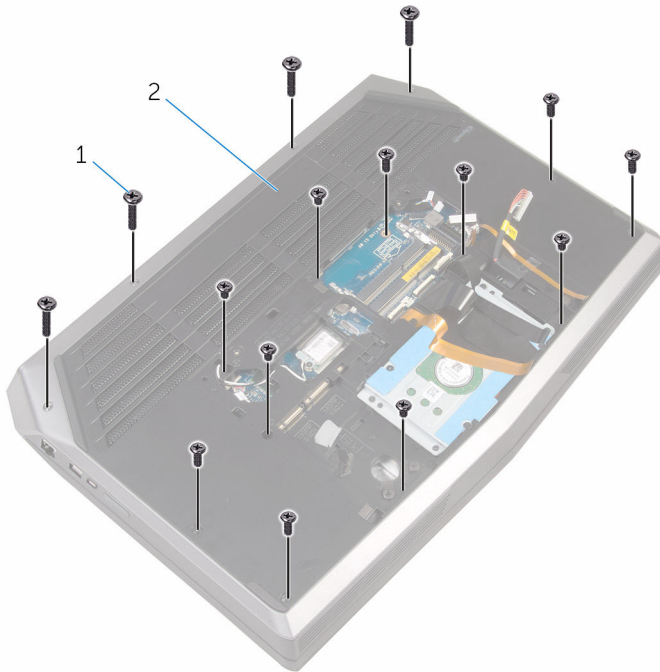

1 screws (15)

2 computer base

- 4** Turn the computer over and open the display as far as possible.
5 Lift the computer base and rest the display on a clean and flat surface.

- 6** Push the palm-rest assembly from the release hole to release it from the tabs on the computer base.

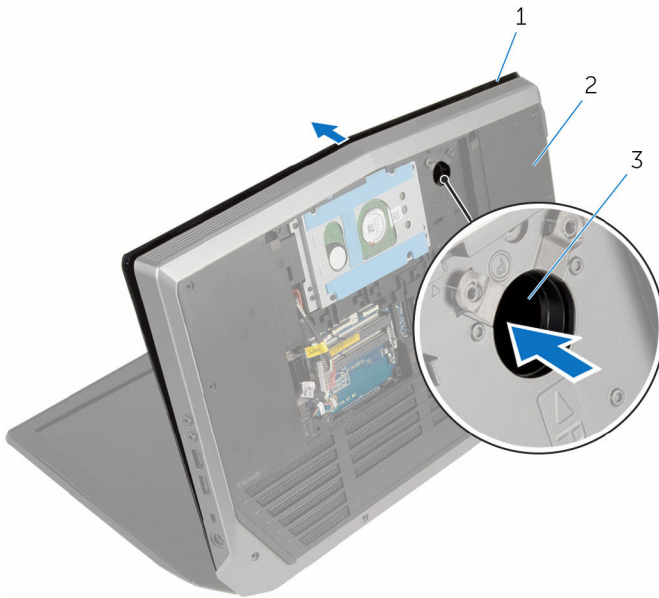

1 palm-rest assembly

2 computer base

3 release hole

- 7** Place the computer in an upright position.

- 8** Using a plastic scribe, pry up along the edges of the palm-rest assembly.

- 9** Gently lift the palm-rest assembly and remove the keyboard cable, keyboard-backlight cable, macro-keys cable, and macro-keys backlight cable from the slot on the computer base.



1 palm-rest assembly

2 plastic scribe

- 10** Carefully turn the palm-rest assembly over and disconnect the power-button board cable from the system board.

11 Lift the palm-rest assembly off the computer base.

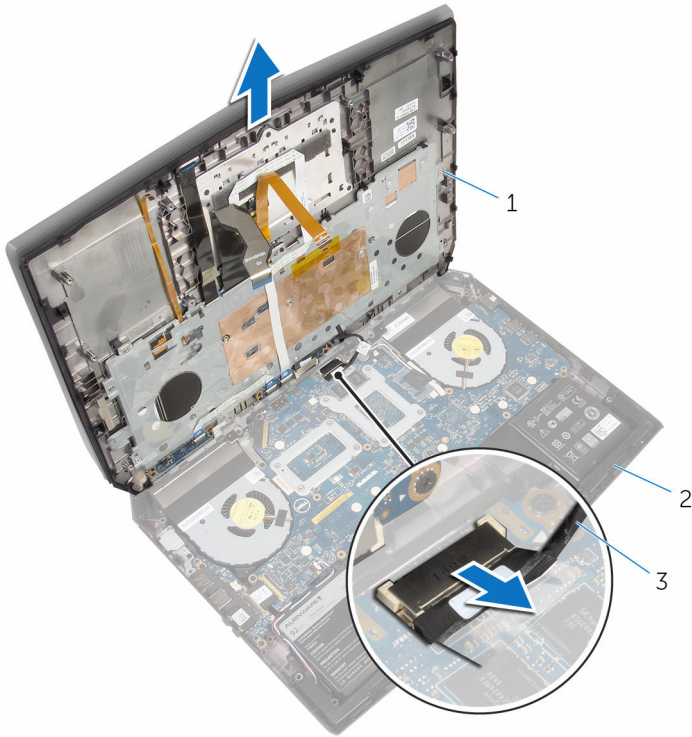

1 palm-rest assembly

2 computer base

3 power-button board cable

12 Turn the palm-rest assembly over.

13 Follow the procedure from step 1 to step 6 in "Removing the [keyboard](#)".

14 Follow the procedure from step 1 to step 4 in "Removing the [power-button board](#)".

15 Follow the procedure from step 1 to step 3 in "Removing the [status-light board](#)".

16 Follow the procedure from step 1 to step 5 in "Removing the [touch pad](#)".

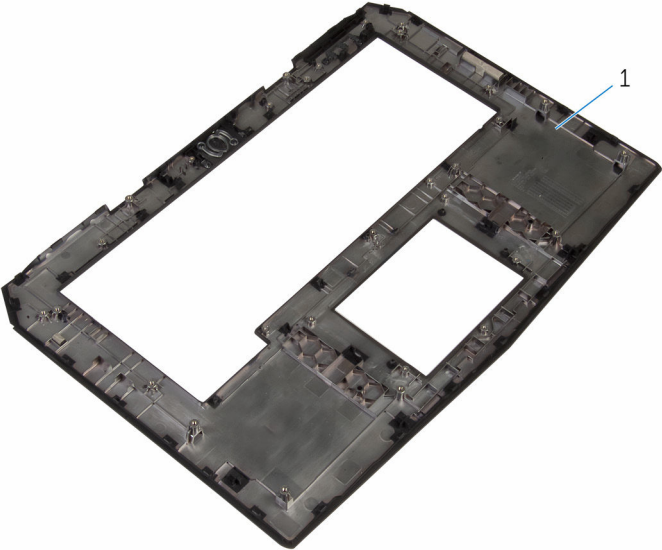

1 palm rest

Replacing the palm rest



WARNING: Before working inside your computer, read the safety information that shipped with your computer and follow the steps in [Before working inside your computer](#). After working inside your computer, follow the instructions in [After working inside your computer](#). For more safety best practices, see the Regulatory Compliance home page at www.dell.com/regulatory_compliance.

Procedure

- 1 Follow the procedure from step 1 to step 5 in "Replacing the [touch pad](#)".
- 2 Follow the procedure from step 1 to step 3 in "Replacing the [status-light board](#)".
- 3 Follow the procedure from step 1 to step 4 in "Replacing the [power-button board](#)".
- 4 Follow the procedure from step 1 to step 7 in "Replacing the [keyboard](#)".
- 5 Connect the power-button board cable to the system board.
- 6 Carefully turn the palm-rest assembly over and slide the keyboard cable, keyboard-backlight cable, macro-keys cable, and macro-keys backlight cable into the slot on the computer base.
- 7 Align the palm-rest assembly on the computer base and snap it into place.
- 8 Close the display and turn the computer over.
- 9 Replace the screws that secure the palm-rest assembly to the computer base.
- 10 Slide the keyboard-backlight cable, keyboard cable, macro-keys cable, and macro-keys backlight cable into the system board and press down on the latches to secure the cables.
- 11 Route the keyboard-backlight cable, keyboard cable, and macro-keys cable through the routing guides on the computer base.

Post-requisites

- 1 Replace the [solid-state drives](#).
- 2 Replace the [memory modules](#).
- 3 Replace the [base panel](#).

Removing the touch pad



WARNING: Before working inside your computer, read the safety information that shipped with your computer and follow the steps in [Before working inside your computer](#). After working inside your computer, follow the instructions in [After working inside your computer](#). For more safety best practices, see the Regulatory Compliance home page at www.dell.com/regulatory_compliance.

Prerequisites

- 1 Remove the [base panel](#).
- 2 Remove the [memory modules](#).
- 3 Remove the [solid-state drives](#).
- 4 Follow the procedure from step 1 to step 12 in "Removing the [palm rest](#)".

Procedure

- 1 Lift the latches and disconnect the touch-pad cable and touch-pad buttons cable from the touch pad.
- 2 Peel off the touch-pad cable from the touch pad.

- 3** Remove the screws that secure the touch-pad bracket to the palm-rest assembly.

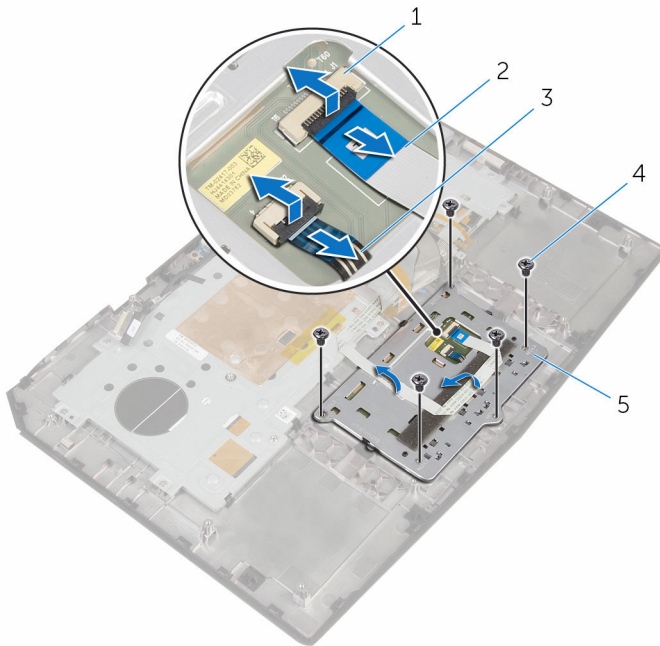

- | | | | |
|---|-------------------------|---|-----------------|
| 1 | latches (2) | 2 | touch-pad cable |
| 3 | touch-pad buttons cable | 4 | screws (5) |
| 5 | touch-pad bracket | | |

- 4** Release the tabs that secure the touch-pad bracket to the palm-rest assembly and lift the touch-pad bracket off the palm-rest assembly.

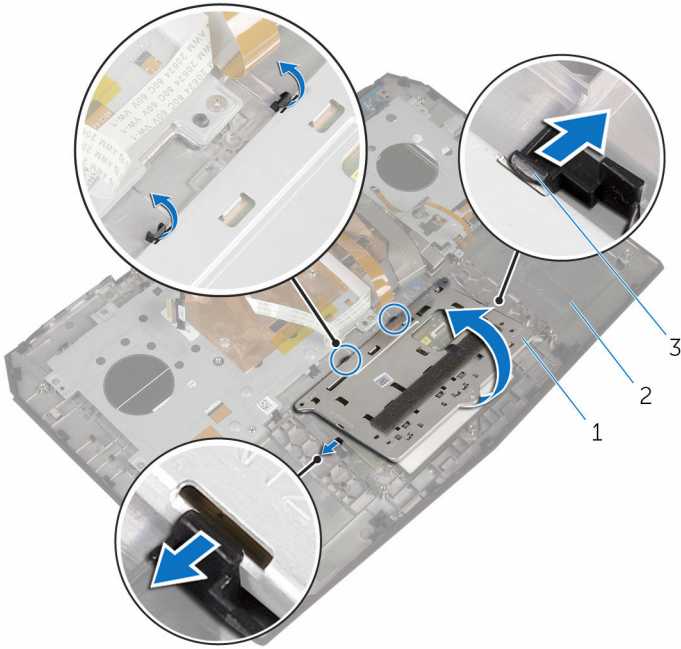

1 touch-pad bracket

2 palm-rest assembly

3 tabs (4)

5 Lift the touch pad off the palm-rest assembly.

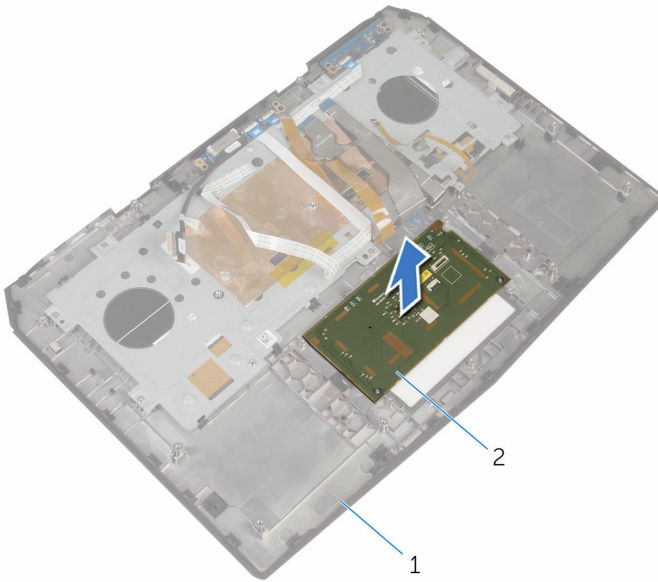

1 palm-rest assembly

2 touch pad

Replacing the touch pad



WARNING: Before working inside your computer, read the safety information that shipped with your computer and follow the steps in [Before working inside your computer](#). After working inside your computer, follow the instructions in [After working inside your computer](#). For more safety best practices, see the Regulatory Compliance home page at www.dell.com/regulatory_compliance.

Procedure

- 1 Using the alignment posts on the palm-rest assembly, place the touch pad on the palm-rest assembly.
- 2 Align the screw holes on the touch-pad bracket with the screw holes on the palm-rest assembly and snap the touch-pad bracket into place.
- 3 Replace the screws that secure the touch-pad bracket to the palm-rest assembly.
- 4 Adhere the touch-pad cable to the touch pad.
- 5 Slide the touch-pad cable and touch-pad buttons cable into the touch pad and press down on the latches to secure the cables.

Post-requisites

- 1 Follow the procedure from step 5 to step 11 in "Replacing the [palm rest](#)".
- 2 Replace the [solid-state drives](#).
- 3 Replace the [memory modules](#).
- 4 Replace the [base panel](#).

Removing the keyboard



WARNING: Before working inside your computer, read the safety information that shipped with your computer and follow the steps in [Before working inside your computer](#). After working inside your computer, follow the instructions in [After working inside your computer](#). For more safety best practices, see the Regulatory Compliance home page at www.dell.com/regulatory_compliance.

Prerequisites

- 1 Remove the [base panel](#).
- 2 Remove the [memory modules](#).
- 3 Remove the [solid-state drives](#).
- 4 Follow the procedure from step 1 to step 12 in "Removing the [palm rest](#)".

Procedure

- 1 Lift the latches and disconnect the touch-pad cable and the status-light cable from the power-button board.

- 2 Note the touch-pad cable and status-light cable routings and peel off the cables from the keyboard bracket.

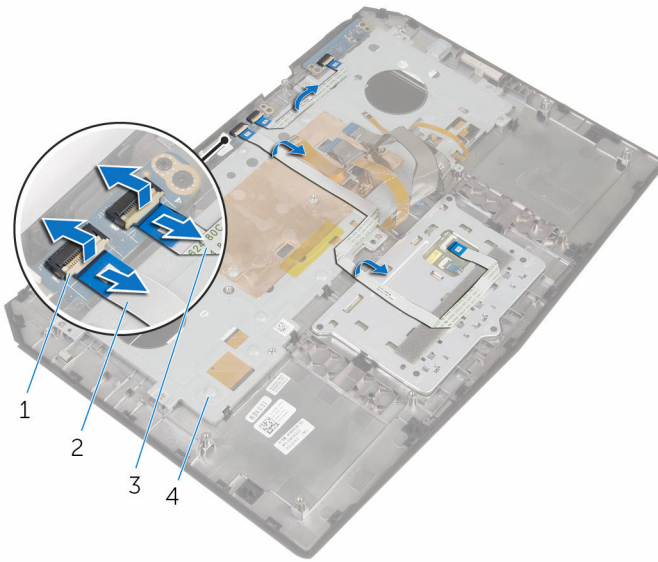

- | | | | |
|---|--------------------|---|------------------|
| 1 | latches (2) | 2 | touch-pad cable |
| 3 | status-light cable | 4 | keyboard bracket |

- 3** Remove the screws that secure the keyboard bracket to the palm-rest assembly.

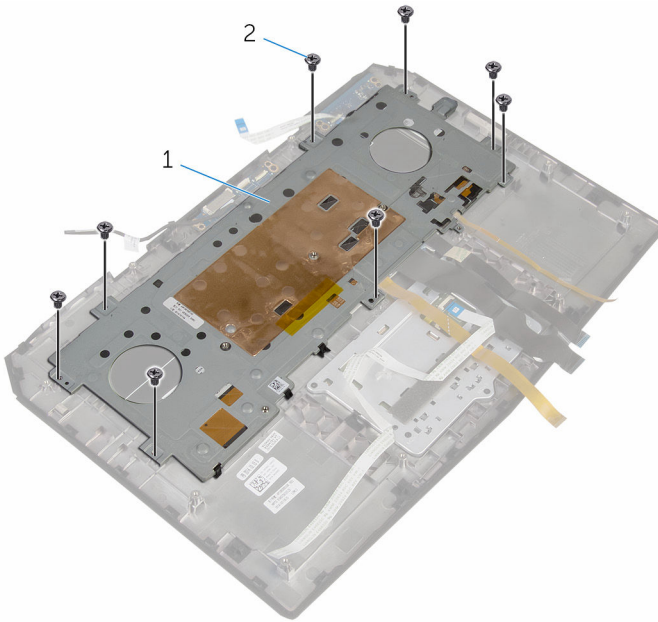

1 keyboard bracket

2 screws (8)

- 4 Lift the keyboard bracket at an angle and remove it from the tabs on the palm-rest assembly.

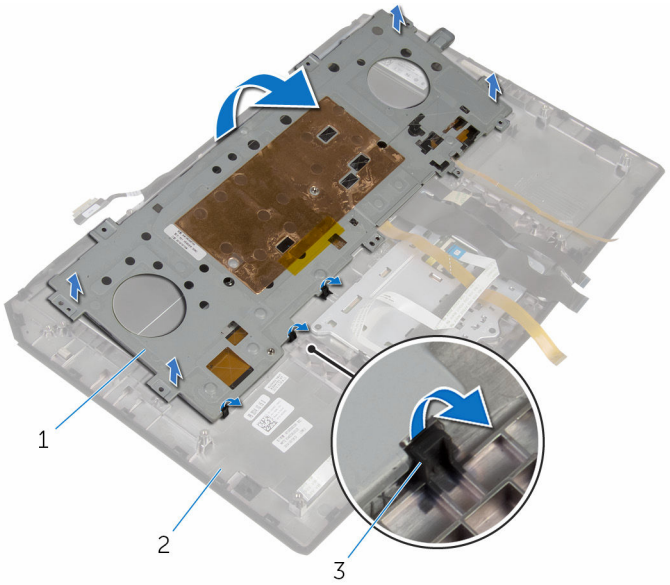

1 keyboard bracket

2 palm-rest assembly

3 tabs (3)

- 5 Remove the screws that secure the keyboard to the palm-rest assembly.

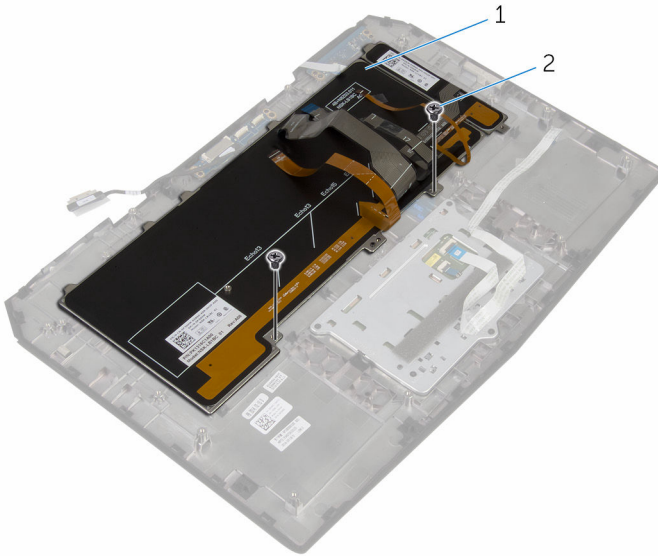

1 keyboard

2 screws (2)

- 6** Lift the keyboard at an angle and remove it from the tabs on the palm-rest assembly.

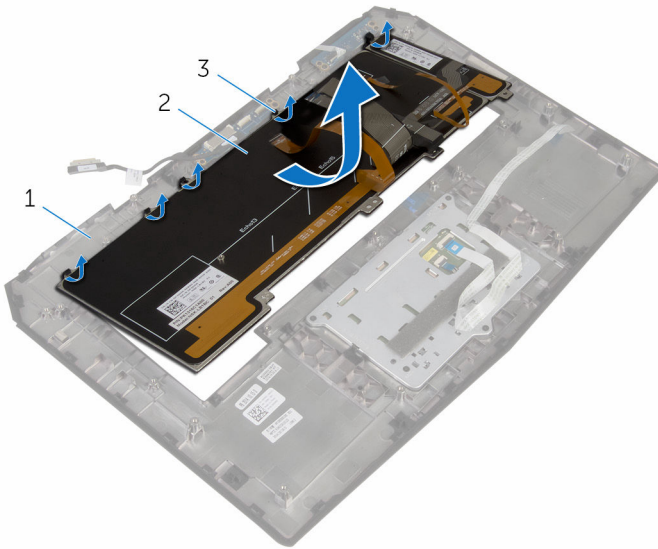

1 palm-rest assembly

2 keyboard

3 tabs (5)

Replacing the keyboard

 **WARNING:** Before working inside your computer, read the safety information that shipped with your computer and follow the steps in [Before working inside your computer](#). After working inside your computer, follow the instructions in [After working inside your computer](#). For more safety best practices, see the Regulatory Compliance home page at www.dell.com/regulatory_compliance.

Procedure

 **CAUTION:** Make sure that no cables are under the keyboard.

- 1 Slide the keyboard under the tabs on the palm-rest assembly.
- 2 Align the screw holes on the keyboard with the screw holes on the palm-rest assembly.
- 3 Replace the screws that secure the keyboard to the palm-rest assembly.
- 4 Align the screw holes on the keyboard bracket with the screw holes on the palm-rest assembly and snap the keyboard bracket into place.
- 5 Replace the screws that secure the keyboard bracket to the palm-rest assembly.
- 6 Adhere the touch-pad cable and status-light cable to the keyboard bracket.
- 7 Slide the touch-pad cable and the status-light cable into the power-button board and press down on the latches to secure the cables.

Post-requisites

- 1 Follow the procedure from step 5 to step 12 in "Replacing the [palm rest](#)".
- 2 Replace the [solid-state drives](#).
- 3 Replace the [memory modules](#).
- 4 Replace the [base panel](#).

Removing the power-button board



WARNING: Before working inside your computer, read the safety information that shipped with your computer and follow the steps in [Before working inside your computer](#). After working inside your computer, follow the instructions in [After working inside your computer](#). For more safety best practices, see the Regulatory Compliance home page at www.dell.com/regulatory_compliance.

Prerequisites

- 1 Remove the [base panel](#).
- 2 Remove the [memory modules](#).
- 3 Remove the [solid-state drives](#).
- 4 Follow the procedure from step 1 to step 12 in “Removing the [palm rest](#)”.

Procedure

- 1 Lift the latches and disconnect the touch-pad cable and status-light cable from the power-button board.

- 2** Disconnect the power-button board cable from the power-button board.

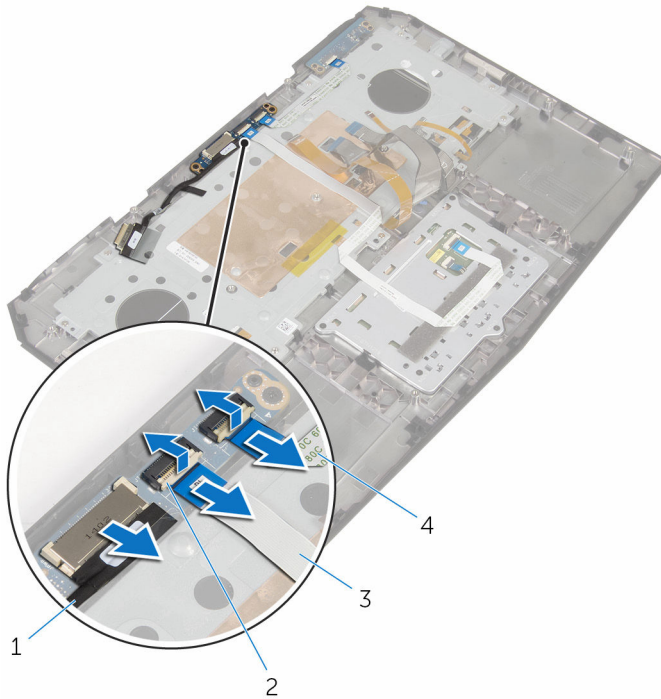

- | | | | |
|---|--------------------------|---|--------------------|
| 1 | power-button board cable | 2 | latches (2) |
| 3 | touch-pad cable | 4 | status-light cable |

- 3** Remove the screws that secure the power-button board to the palm-rest assembly.

4 Lift the power-button board off the palm-rest assembly.

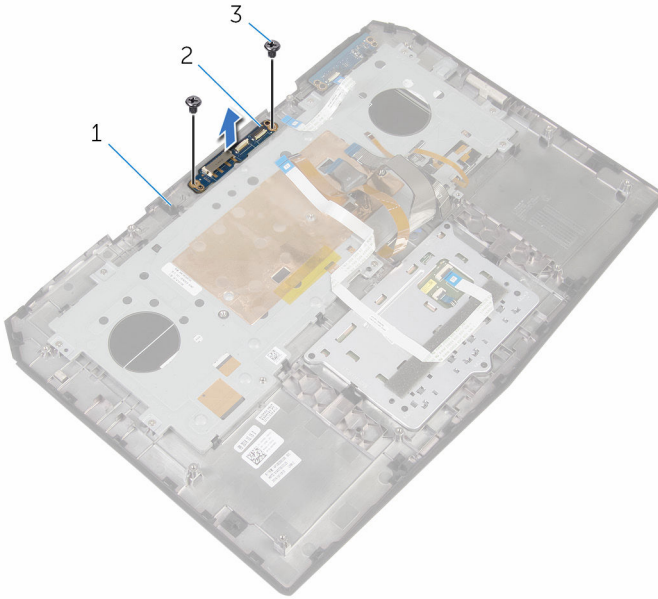

1 palm-rest assembly

2 power-button board

3 screws (2)

Replacing the power-button board



WARNING: Before working inside your computer, read the safety information that shipped with your computer and follow the steps in [Before working inside your computer](#). After working inside your computer, follow the instructions in [After working inside your computer](#). For more safety best practices, see the Regulatory Compliance home page at www.dell.com/regulatory_compliance.

Procedure

- 1 Align the screw holes on the power-button board with the screw holes on the palm-rest assembly.
- 2 Replace the screws that secure the power-button board to the palm-rest assembly.
- 3 Slide the touch-pad cable and status-light cable into the power-button board and press down on the latches to secure the cables.
- 4 Connect the power-button board cable to the power-button board.

Post-requisites

- 1 Follow the procedure from step 5 to step 11 in "Replacing the [palm rest](#)".
- 2 Replace the [solid-state drives](#).
- 3 Replace the [memory modules](#).
- 4 Replace the [base panel](#).

Removing the status-light board



WARNING: Before working inside your computer, read the safety information that shipped with your computer and follow the steps in [Before working inside your computer](#). After working inside your computer, follow the instructions in [After working inside your computer](#). For more safety best practices, see the Regulatory Compliance home page at www.dell.com/regulatory_compliance.

Prerequisites

- 1 Remove the [base panel](#).
- 2 Remove the [memory modules](#).
- 3 Remove the [solid-state drives](#).
- 4 Follow the procedure from step 1 to step 12 in “Removing the [palm rest](#)”.

Procedure

- 1 Lift the latch and disconnect the status-light board cable from the status-light board.

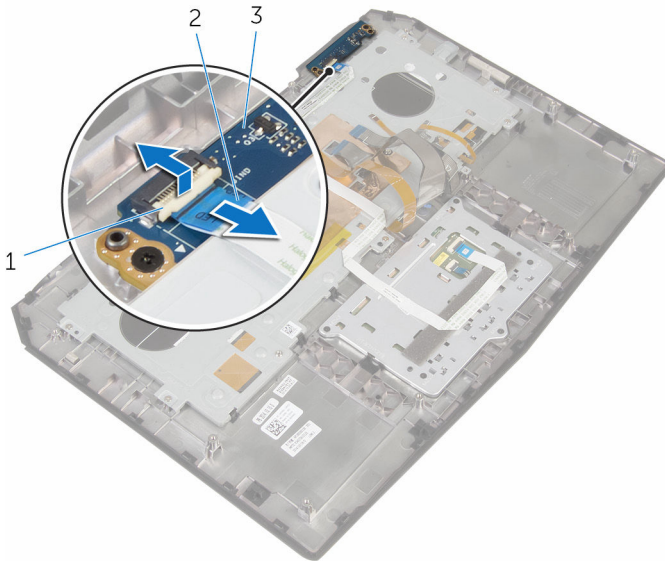

- | | | | |
|---|--------------------|---|--------------------------|
| 1 | latch | 2 | status-light board cable |
| 3 | status-light board | | |

- 2 Remove the screws that secure the status-light board to the palm-rest assembly.

3 Lift the status-light board off the palm-rest assembly.

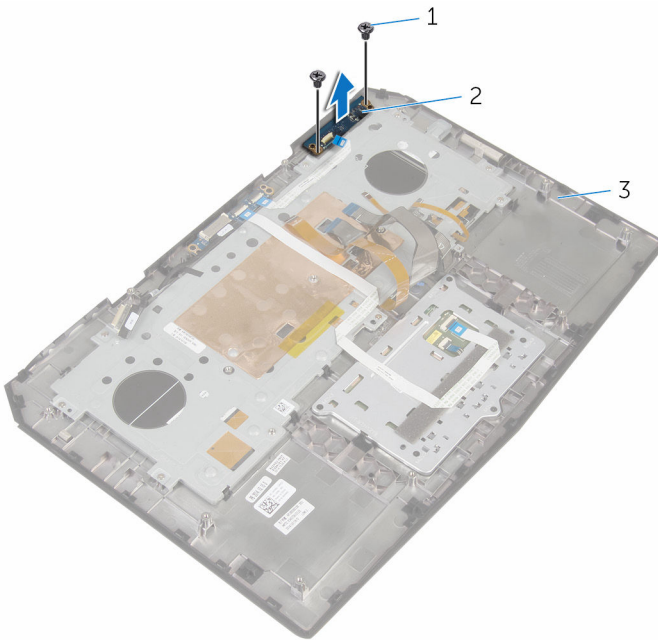

1 screws (2)

2 status-light board

3 palm-rest assembly

Replacing the status-light board



WARNING: Before working inside your computer, read the safety information that shipped with your computer and follow the steps in [Before working inside your computer](#). After working inside your computer, follow the instructions in [After working inside your computer](#). For more safety best practices, see the Regulatory Compliance home page at www.dell.com/regulatory_compliance.

Procedure

- 1 Align the screw holes on the status-light board with the screw holes on the palm-rest assembly.
- 2 Replace the screws that secure the status-light board to the palm-rest assembly.
- 3 Slide the status-light board cable into the status-light board and press down on the latch to secure the cable.

Post-requisites

- 1 Follow the procedure from step 5 to step 11 in “Replacing the [palm rest](#)”.
- 2 Replace the [solid-state drives](#).
- 3 Replace the [memory modules](#).
- 4 Replace the [base panel](#).

Removing the I/O board



WARNING: Before working inside your computer, read the safety information that shipped with your computer and follow the steps in [Before working inside your computer](#). After working inside your computer, follow the instructions in [After working inside your computer](#). For more safety best practices, see the Regulatory Compliance home page at www.dell.com/regulatory_compliance.

Prerequisites

- 1 Remove the [base panel](#).
- 2 Remove the [memory module](#).
- 3 Remove the [solid-state drives](#).
- 4 Follow the procedure from step 1 to step 11 in “Removing the [palm rest](#)”.

Procedure

- 1 Lift the latch and disconnect the I/O-board cable from the I/O board.
- 2 Remove the screws that secure the I/O-board to the computer base.

3 Lift the I/O board off the computer base.

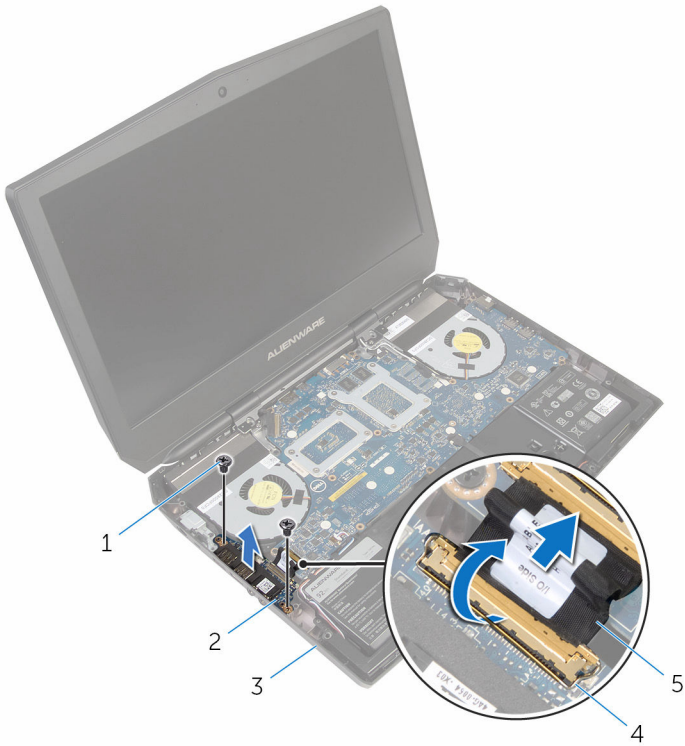

1 screws (2)

3 computer base

5 I/O-board cable

2 I/O board

4 latch

Replacing the I/O board



WARNING: Before working inside your computer, read the safety information that shipped with your computer and follow the steps in [Before working inside your computer](#). After working inside your computer, follow the instructions in [After working inside your computer](#). For more safety best practices, see the Regulatory Compliance home page at www.dell.com/regulatory_compliance.

Procedure

- 1 Align the screw holes on the I/O board with the screw holes on the computer base.
- 2 Replace the screws that secure the I/O board to the computer base.
- 3 Slide the I/O-board cable into the I/O board and press down on the latch to secure the cable.

Post-requisites

- 1 Follow the procedure from step 5 to step 11 in "Replacing the [palm rest](#)".
- 2 Replace the [solid-state drives](#).
- 3 Replace the [memory module](#).
- 4 Replace the [base panel](#).

Removing the speakers



WARNING: Before working inside your computer, read the safety information that shipped with your computer and follow the steps in [Before working inside your computer](#). After working inside your computer, follow the instructions in [After working inside your computer](#). For more safety best practices, see the Regulatory Compliance home page at www.dell.com/regulatory_compliance.

Prerequisites

- 1 Remove the [base panel](#).
- 2 Remove the [memory modules](#).
- 3 Remove the [solid-state drives](#).
- 4 Follow the procedure from step 1 to step 11 in “Removing the [palm rest](#)”.

Procedure

- 1 Disconnect the speaker cable from the system board.
- 2 Peel of the tape and disconnect the front AlienFX LED cable from the system board.

- 3** Note the front AlienFX LED cable routing and peel off the cable from the battery.



- | | | | |
|---|-------------------------|---|--------------|
| 1 | speaker cable | 2 | tape |
| 3 | front AlienFX LED cable | 4 | speakers (2) |

- 4** Remove the speaker cable from the routing guides on the battery and computer base.

5 Lift the speakers along with its cable off the computer base.

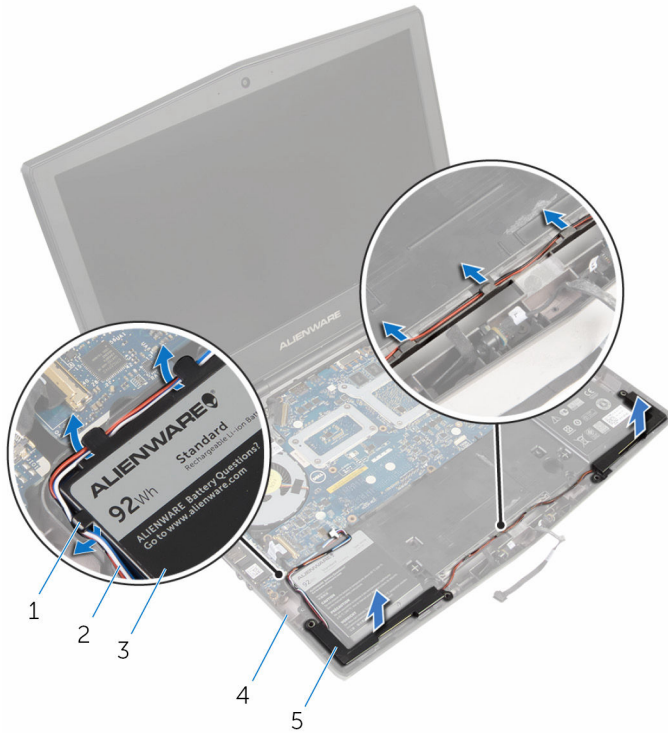

1 routing guides (6)

2 speaker cable

3 battery

4 computer base

5 speakers (2)

Replacing the speakers



WARNING: Before working inside your computer, read the safety information that shipped with your computer and follow the steps in [Before working inside your computer](#). After working inside your computer, follow the instructions in [After working inside your computer](#). For more safety best practices, see the Regulatory Compliance home page at www.dell.com/regulatory_compliance.

Procedure

- 1 Using the alignment posts, place the speakers on the computer base.
- 2 Route the speaker cable through the routing guides on the battery and computer base.
- 3 Adhere the front AlienFX LED cable to the battery.
- 4 Connect the front AlienFX LED cable to the system board and secure it with the tape.
- 5 Connect the speaker cable to the system board.

Post-requisites

- 1 Follow the procedure from step 5 to step 11 in “Replacing the [palm rest](#)”.
- 2 Replace the [solid-state drives](#).
- 3 Replace the [memory modules](#).
- 4 Replace the [base panel](#).

Removing the front AlienFX LED boards

 **WARNING:** Before working inside your computer, read the safety information that shipped with your computer and follow the steps in [Before working inside your computer](#). After working inside your computer, follow the instructions in [After working inside your computer](#). For more safety best practices, see the Regulatory Compliance home page at www.dell.com/regulatory_compliance.

Prerequisites

- 1 Remove the [base panel](#).
- 2 Remove the [memory modules](#).
- 3 Remove the [solid-state drives](#).
- 4 Follow the procedure from step 1 to step 11 in “Removing the [palm rest](#)”.

Procedure

- 1 Remove the screws that secure the front AlienFX LED boards to the computer base.
- 2 Lift the front AlienFX LED boards and disconnect the front AlienFX LED board cables from the front AlienFX LED boards.
- 3 Remove the screws that secure the front AlienFX LED boards to the tubes.

4 Lift the front AlienFX LED boards off the tubes.

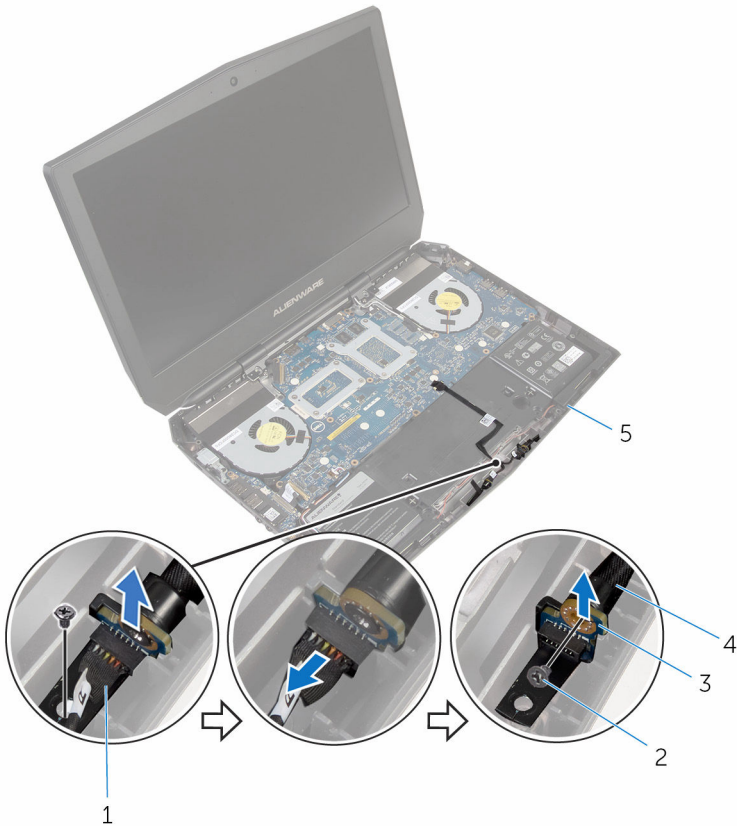

- | | | | |
|---|------------------------------------|---|------------|
| 1 | front AlienFX LED board cables (2) | 2 | screws (4) |
| 3 | front AlienFX LED boards (2) | 4 | tubes (2) |
| 5 | computer base | | |

Replacing the front AlienFX LED board

 **WARNING:** Before working inside your computer, read the safety information that shipped with your computer and follow the steps in [Before working inside your computer](#). After working inside your computer, follow the instructions in [After working inside your computer](#). For more safety best practices, see the Regulatory Compliance home page at www.dell.com/regulatory_compliance.

Procedure

- 1 Align the screw holes on the front AlienFX LED boards with the screw holes on the tubes.
- 2 Replace the screws that secure the front AlienFX LED boards to the tubes.
- 3 Connect the front AlienFX LED board cables to the front AlienFX LED boards.
- 4 Align the screw holes on the front AlienFX LED boards with the screw holes on the computer base.
- 5 Replace the screws that secure the front AlienFX LED board to the computer base.

Post-requisites

- 1 Follow the procedure from step 5 to step 11 in “Replacing the [palm rest](#)”.
- 2 Replace the [solid-state drives](#).
- 3 Replace the [memory modules](#).
- 4 Replace the [base panel](#).

Removing the hinge covers



WARNING: Before working inside your computer, read the safety information that shipped with your computer and follow the steps in [Before working inside your computer](#). After working inside your computer, follow the instructions in [After working inside your computer](#). For more safety best practices, see the Regulatory Compliance home page at www.dell.com/regulatory_compliance.

Prerequisites

- 1 Remove the [base panel](#).
- 2 Remove the [memory modules](#).
- 3 Remove the [solid-state drives](#).
- 4 Follow the procedure from step 1 to step 11 in “Removing the [palm rest](#)”.

Procedure

- 1 Remove the screws that secure the hinge covers to the computer base.
- 2 Open the display as far as possible.

3 Remove the hinge covers from the computer base.

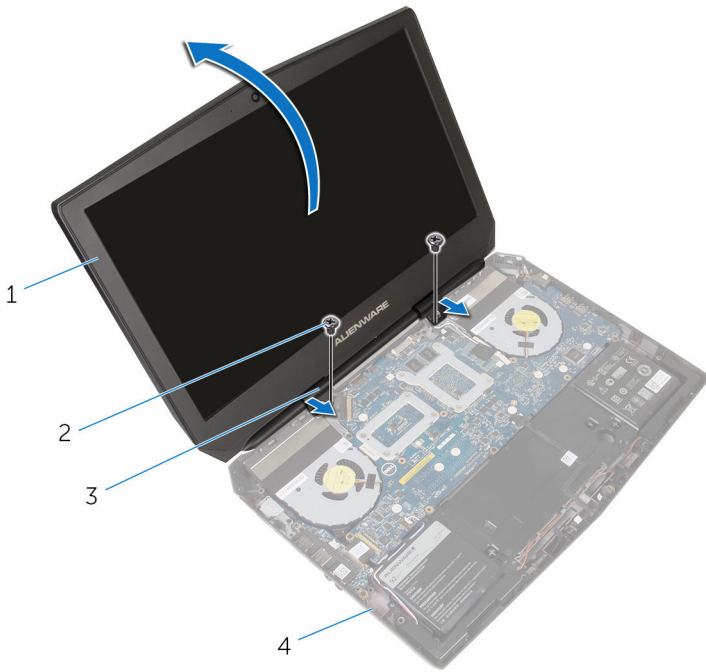

1 display assembly

2 screws (2)

3 hinge covers (2)

4 computer base

Replacing the hinge covers



WARNING: Before working inside your computer, read the safety information that shipped with your computer and follow the steps in [Before working inside your computer](#). After working inside your computer, follow the instructions in [After working inside your computer](#). For more safety best practices, see the Regulatory Compliance home page at www.dell.com/regulatory_compliance.

Procedure

- 1 Align the screw holes on the hinge covers with the screw holes on the computer base and snap the hinge covers into place.
- 2 Replace the screws that secure the hinge covers to the computer base.

Post-requisites

- 1 Follow the procedure from step 5 to step 11 in “Replacing the [palm rest](#)”.
- 2 Replace the [solid-state drives](#).
- 3 Replace the [memory modules](#).
- 4 Replace the [base panel](#).

Removing the display assembly



WARNING: Before working inside your computer, read the safety information that shipped with your computer and follow the steps in [Before working inside your computer](#). After working inside your computer, follow the instructions in [After working inside your computer](#). For more safety best practices, see the Regulatory Compliance home page at www.dell.com/regulatory_compliance.

Prerequisites

- 1 Remove the [base panel](#).
- 2 Remove the [memory modules](#).
- 3 Remove the [solid-state drives](#).
- 4 Remove the [wireless card](#).
- 5 Follow the procedure from step 1 to step 11 in “Removing the [palm rest](#)”.
- 6 Remove the [hinge covers](#).

Procedure

- 1 Close the display and turn the computer over.
- 2 Remove the antenna cables from the routing guide on the computer base.

- 3 Remove the screws that secure the display assembly to the computer base.



- | | | | |
|---|------------------|---|---------------|
| 1 | display assembly | 2 | computer base |
| 3 | screws (2) | | |

- 4 Turn the computer over and open the display as far as possible.
- 5 Carefully remove the antenna cables through the slot on the computer base.
- 6 Peel off the adhesive tape that secures the antenna cables to the system board.
- 7 Remove the antenna cables from the routing guide on the display hinges.
- 8 Lift the latch and disconnect the display cable from the system board.

- 9** Peel off the adhesive tape, disconnect the logo-board cable from the system board, and remove it from the routing guide on the display hinges.

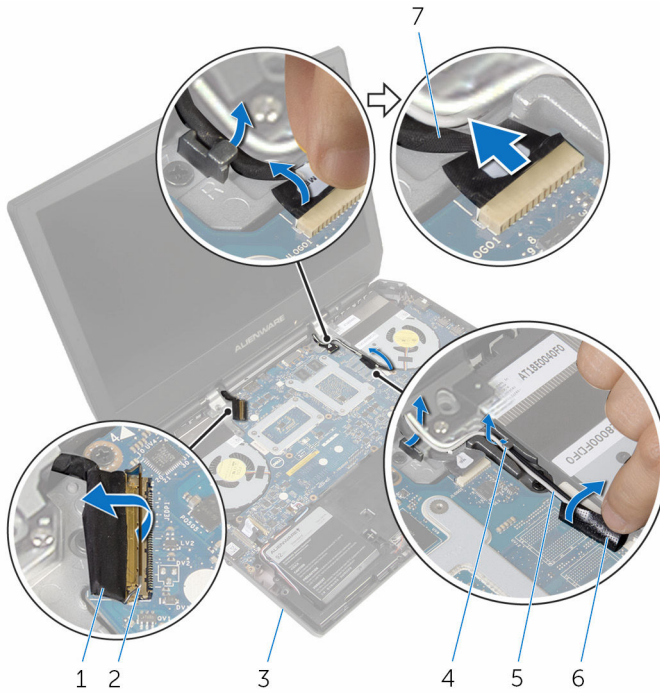

- | | | | |
|---|--------------------|---|--------------------|
| 1 | display cable | 2 | latch |
| 3 | computer base | 4 | routing guides (2) |
| 5 | antenna cables (2) | 6 | adhesive tapes (2) |
| 7 | logo-board cable | | |

- 10** Remove the screws that secure the display assembly to the computer base.

11 Lift the display assembly off the computer base.

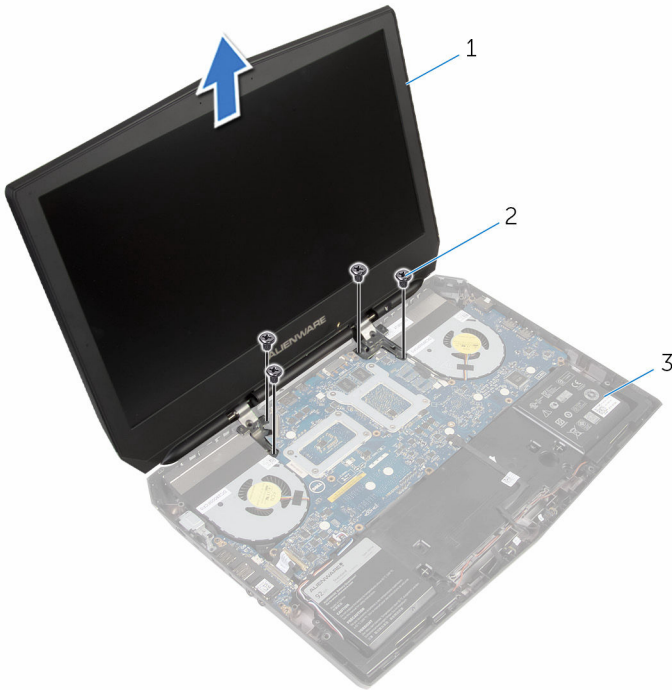

1 display assembly

2 screws (4)

3 computer base

Replacing the display assembly



WARNING: Before working inside your computer, read the safety information that shipped with your computer and follow the steps in [Before working inside your computer](#). After working inside your computer, follow the instructions in [After working inside your computer](#). For more safety best practices, see the Regulatory Compliance home page at www.dell.com/regulatory_compliance.

Procedure

- 1 Align the screw holes on the display hinges with the screw holes on the computer base.
- 2 Replace the screws that secure the display hinges to the computer base.
- 3 Route the logo-board cable through the routing guide on the display hinge.
- 4 Connect the logo-board cable to the system board and secure it with the tape.
- 5 Slide the display cable into the system board and press down on the latch to secure the cable.
- 6 Route the antenna cables through the routing guide on the display hinges.
- 7 Adhere the adhesive tape that secure the antenna cables to the system board.
- 8 Slide the antenna cables through the slot on the computer base.
- 9 Close the display and turn the computer over.
- 10 Route the antenna cables through the routing guide on the computer base.
- 11 Replace the screws that secure the display assembly to the computer base.
- 12 Turn the computer over and open the display as far as possible.

Post-requisites

- 1 Replace the [hinge covers](#).
- 2 Follow the procedure from step 5 to step 11 in "Replacing the [palm rest](#)".

- 3** Replace the [wireless card](#).
- 4** Replace the [solid-state drives](#).
- 5** Replace the [memory modules](#).
- 6** Replace the [base panel](#).

Removing the display bezel



WARNING: Before working inside your computer, read the safety information that shipped with your computer and follow the steps in [Before working inside your computer](#). After working inside your computer, follow the instructions in [After working inside your computer](#). For more safety best practices, see the Regulatory Compliance home page at www.dell.com/regulatory_compliance.

Prerequisites

- 1 Remove the [base panel](#).
- 2 Remove the [memory modules](#).
- 3 Remove the [solid-state drives](#).
- 4 Remove the [wireless card](#).
- 5 Follow the procedure from step 1 to step 11 in “Removing the [palm rest](#)”.
- 6 Remove the [hinge covers](#).
- 7 Remove the [display assembly](#).

Procedure

- 1 Using your fingertips, carefully pry up the inside edges of the display bezel.

- 2** Carefully lift the display bezel and turn it over.



1 display bezel

- 3** Lift the latches and disconnect the display-board cables from the logo board.

- 4 Peel off the adhesive tape and disconnect the logo-board cable from the logo board.

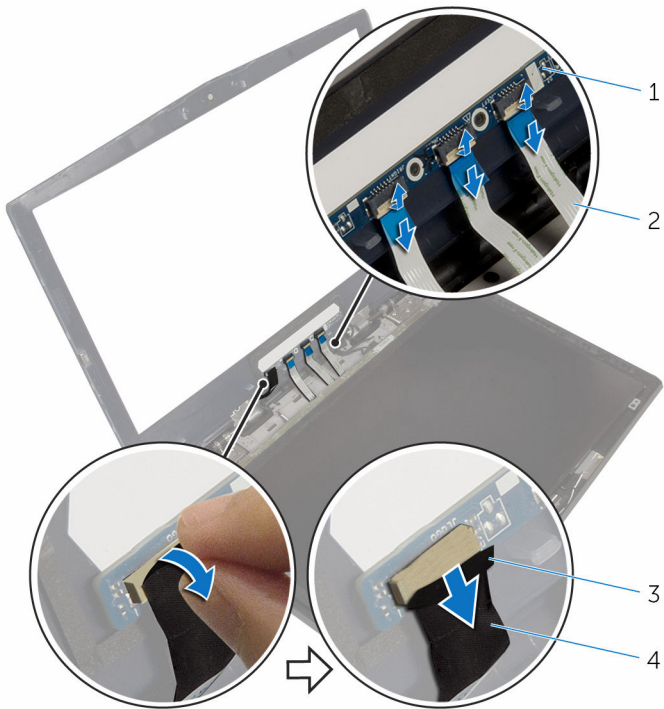

- | | | | |
|---|---------------|---|--------------------------|
| 1 | logo board | 2 | display-board cables (3) |
| 3 | adhesive tape | 4 | logo-board cable |

- 5 Follow the procedure from step 1 to step 2 in “Removing the [logo board](#)”.



- 1 display bezel

Replacing the display bezel



WARNING: Before working inside your computer, read the safety information that shipped with your computer and follow the steps in [Before working inside your computer](#). After working inside your computer, follow the instructions in [After working inside your computer](#). For more safety best practices, see the Regulatory Compliance home page at www.dell.com/regulatory_compliance.

Procedure

- 1 Follow the procedure from step 1 to step 2 in “Replacing the [logo board](#)”.
- 2 Connect the logo-board cable to the logo board and secure it with the adhesive tape.
- 3 Slide the display-board cables into the logo board and press down on the latches to secure the cables.
- 4 Carefully turn the display bezel over.
- 5 Align the display bezel with the display back-cover and gently snap the display bezel into place.

Post-requisites

- 1 Replace the [display assembly](#).
- 2 Replace the [hinge covers](#).
- 3 Follow the procedure from step 5 to step 11 in “Replacing the [palm rest](#)”.
- 4 Replace the [wireless card](#).
- 5 Replace the [solid-state drives](#).
- 6 Replace the [memory modules](#).
- 7 Replace the [base panel](#).

Removing the display panel



WARNING: Before working inside your computer, read the safety information that shipped with your computer and follow the steps in [Before working inside your computer](#). After working inside your computer, follow the instructions in [After working inside your computer](#). For more safety best practices, see the Regulatory Compliance home page at www.dell.com/regulatory_compliance.

Prerequisites

- 1 Remove the [base panel](#).
- 2 Remove the [memory modules](#).
- 3 Remove the [solid-state drives](#).
- 4 Remove the [wireless card](#).
- 5 Follow the procedure from step 1 to step 11 in “Removing the [palm rest](#)”.
- 6 Remove the [hinge covers](#).
- 7 Remove the [display assembly](#).
- 8 Follow the procedure from step 1 to step 4 in “Removing the [display bezel](#)”.

Procedure

- 1 Remove the screws that secure the display panel to the display back-cover.

2 Gently lift the display panel and turn it over.

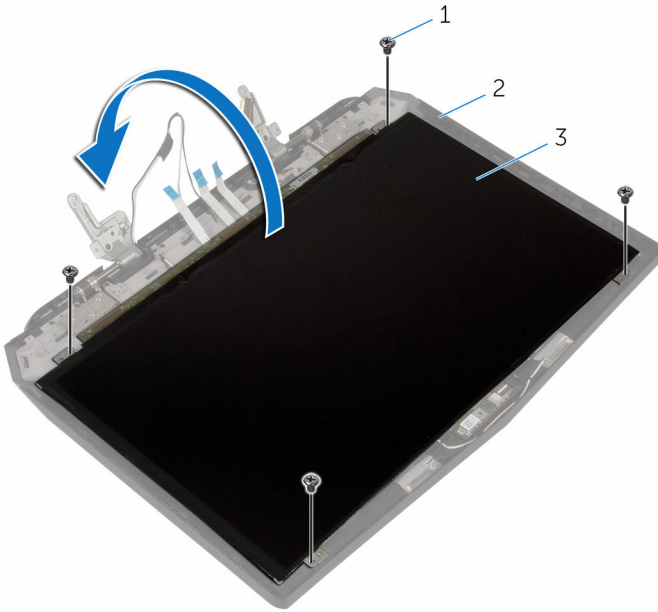

1 screws (4)

2 display back-cover

3 display panel

3 Lift the latch and disconnect the display cable from the display panel.

4 Lift the display panel off the display back-cover.

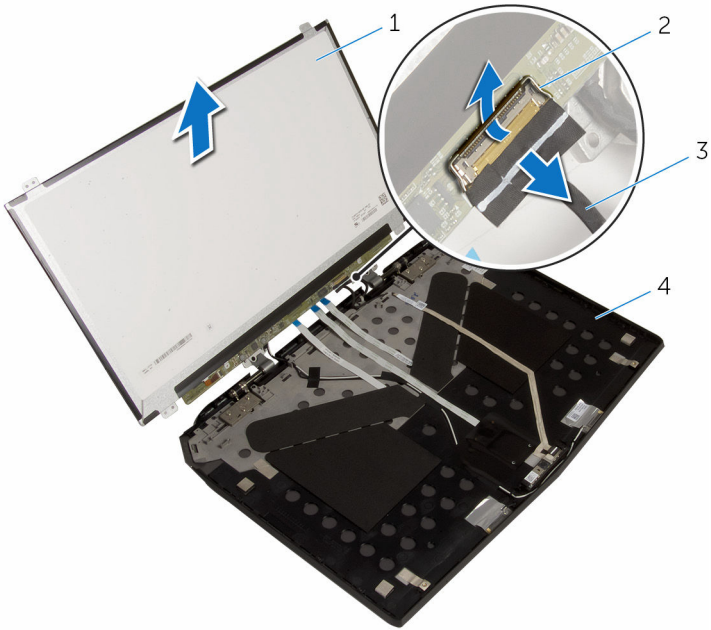

1 display panel

3 display cable

2 latch

4 display back-cover

Replacing the display panel



WARNING: Before working inside your computer, read the safety information that shipped with your computer and follow the steps in [Before working inside your computer](#). After working inside your computer, follow the instructions in [After working inside your computer](#). For more safety best practices, see the Regulatory Compliance home page at www.dell.com/regulatory_compliance.

Procedure

- 1 Slide the display cable into the display panel and press down on the latch to secure the cable.
- 2 Turn the display panel over.
- 3 Align the screw holes on the display panel with the screw holes on the display back-cover.
- 4 Replace the screws that secure the display panel to the display back-cover.

Post-requisites

- 1 Follow the procedure from step 2 to step 5 in “Replacing the [display bezel](#)”.
- 2 Replace the [display assembly](#).
- 3 Replace the [hinge covers](#).
- 4 Follow the procedure from step 5 to step 11 in “Replacing the [palm rest](#)”.
- 5 Replace the [wireless card](#).
- 6 Replace the [solid-state drives](#).
- 7 Replace the [memory modules](#).
- 8 Replace the [base panel](#).

Removing the display hinges



WARNING: Before working inside your computer, read the safety information that shipped with your computer and follow the steps in [Before working inside your computer](#). After working inside your computer, follow the instructions in [After working inside your computer](#). For more safety best practices, see the Regulatory Compliance home page at www.dell.com/regulatory_compliance.

Prerequisites

- 1 Remove the [base panel](#).
- 2 Remove the [memory modules](#).
- 3 Remove the [solid-state drives](#).
- 4 Remove the [wireless card](#).
- 5 Follow the procedure from step 1 to step 11 in “Removing the [palm rest](#)”.
- 6 Remove the [hinge covers](#).
- 7 Remove the [display assembly](#).
- 8 Follow the procedure from step 1 to step 4 in “Removing the [display bezel](#)”.

Procedure

- 1 Remove the screws that secure the display hinges to the display back-cover.

2 Lift the display hinges off the display assembly.

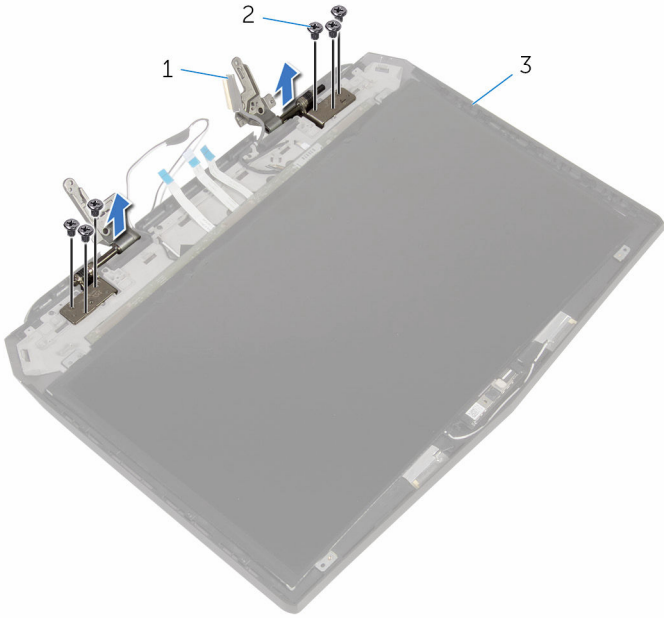

- 1 display hinges (2)
- 3 display back-cover

- 2 screws (6)

Replacing the display hinges



WARNING: Before working inside your computer, read the safety information that shipped with your computer and follow the steps in [Before working inside your computer](#). After working inside your computer, follow the instructions in [After working inside your computer](#). For more safety best practices, see the Regulatory Compliance home page at www.dell.com/regulatory_compliance.

Procedure

- 1 Align the screw holes on the display hinges with the screw holes on the display back-cover.
- 2 Replace the screws that secure the display hinges to the display back-cover.

Post-requisites

- 1 Follow the procedure from step 2 to step 5 in “Replacing the [display bezel](#)”.
- 2 Replace the [display assembly](#).
- 3 Replace the [hinge covers](#).
- 4 Follow the procedure from step 5 to step 11 in “Replacing the [palm rest](#)”.
- 5 Replace the [wireless card](#).
- 6 Replace the [solid-state drives](#).
- 7 Replace the [memory modules](#).
- 8 Replace the [base panel](#).

Removing the camera



WARNING: Before working inside your computer, read the safety information that shipped with your computer and follow the steps in [Before working inside your computer](#). After working inside your computer, follow the instructions in [After working inside your computer](#). For more safety best practices, see the Regulatory Compliance home page at www.dell.com/regulatory_compliance.

Prerequisites

- 1 Remove the [base panel](#).
- 2 Remove the [memory modules](#).
- 3 Remove the [solid-state drives](#).
- 4 Remove the [wireless card](#).
- 5 Follow the procedure from step 1 to step 11 in “Removing the [palm rest](#)”.
- 6 Remove the [hinge covers](#).
- 7 Remove the [display assembly](#).
- 8 Follow the procedure from step 1 to step 4 in “Removing the [display bezel](#)”.
- 9 Remove the [display panel](#).

Procedure

- 1 Peel off the tape that secures the camera cable to the camera and disconnect the camera cable from the camera module.

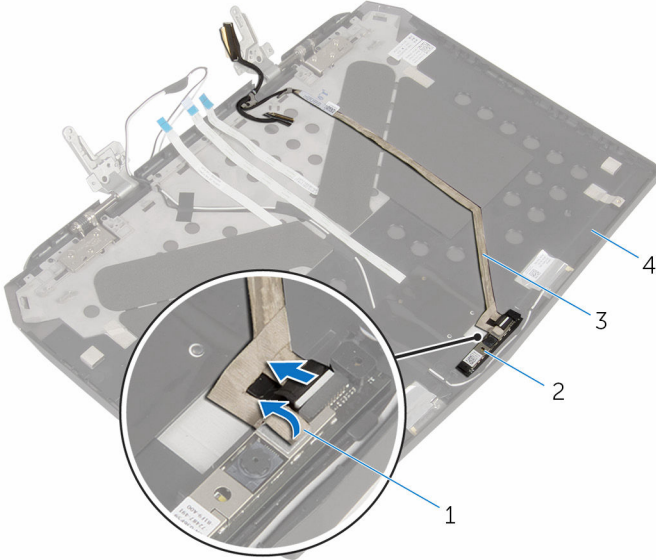

1 tape

3 camera cable

2 camera module

4 display back-cover

- 2** Note the location of the camera module and pry it off the display back-cover using a plastic scribe.

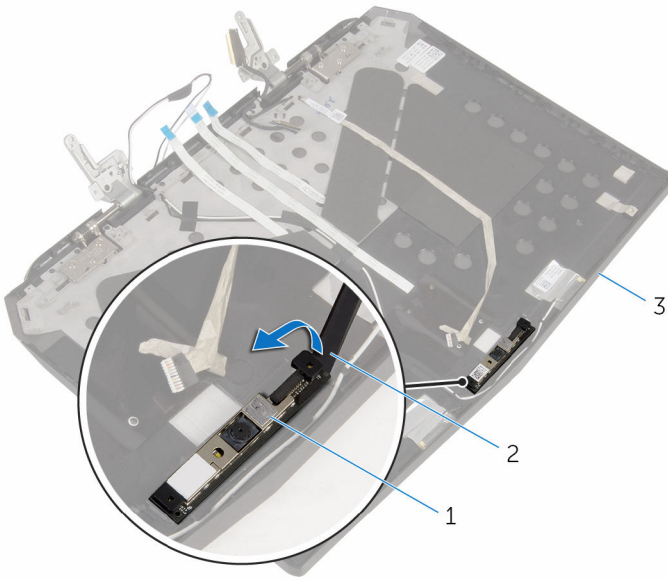

- 1 camera module
3 display back-cover

- 2 plastic scribe

Replacing the camera



WARNING: Before working inside your computer, read the safety information that shipped with your computer and follow the steps in [Before working inside your computer](#). After working inside your computer, follow the instructions in [After working inside your computer](#). For more safety best practices, see the Regulatory Compliance home page at www.dell.com/regulatory_compliance.

Procedure

- 1 Using the alignment posts, adhere the camera module to the display back-cover.
- 2 Connect the camera cable to the camera module and adhere the tape that secures the camera cable to the camera module.

Post-requisites

- 1 Replace the [display panel](#).
- 2 Follow the procedure from step 2 to step 5 in “Replacing the [display bezel](#)”.
- 3 Replace the [display assembly](#).
- 4 Replace the [hinge covers](#).
- 5 Follow the procedure from step 5 to step 11 in “Replacing the [palm rest](#)”.
- 6 Replace the [wireless card](#).
- 7 Replace the [solid-state drives](#).
- 8 Replace the [memory modules](#).
- 9 Replace the [base panel](#).

Removing the display back-cover



WARNING: Before working inside your computer, read the safety information that shipped with your computer and follow the steps in [Before working inside your computer](#). After working inside your computer, follow the instructions in [After working inside your computer](#). For more safety best practices, see the Regulatory Compliance home page at www.dell.com/regulatory_compliance.

Prerequisites

- 1 Remove the [base panel](#).
- 2 Remove the [memory modules](#).
- 3 Remove the [solid-state drives](#).
- 4 Remove the [wireless card](#).
- 5 Follow the procedure from step 1 to step 11 in “Removing the [palm rest](#)”.
- 6 Remove the [hinge covers](#).
- 7 Remove the [display assembly](#).
- 8 Follow the procedure from step 1 to step 4 in “Removing the [display bezel](#)”.
- 9 Remove the [display panel](#).
- 10 Remove the [display hinges](#).
- 11 Remove the [camera](#).

Procedure

- 1 Note the display-board cable routing and remove the cable from the routing guides on the display back-cover.

- 2** Peel off the display board and camera cable from the display back-cover.

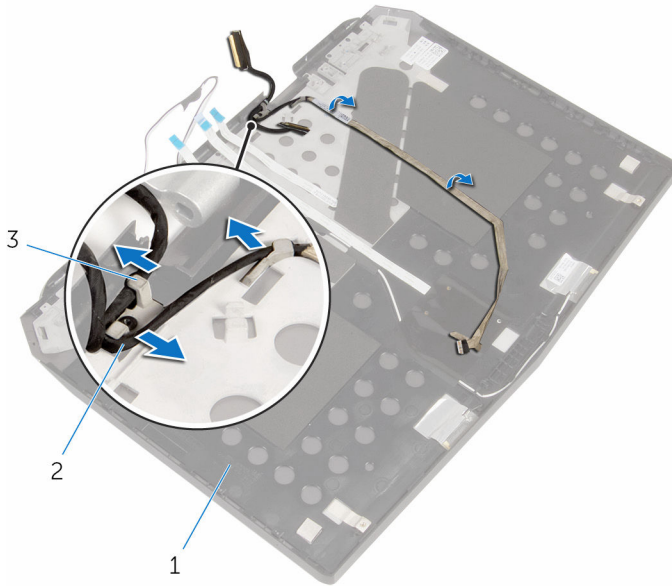

1 display back-cover

2 display board and camera cable

3 routing guides (3)

- 3** Follow the procedure from step 1 to step 4 in "Removing the [Alienware AlienHead LED board](#)".

- 4 Follow the procedure from step 1 to step 4 in "Removing the [display panel AlienFX LED](#)".

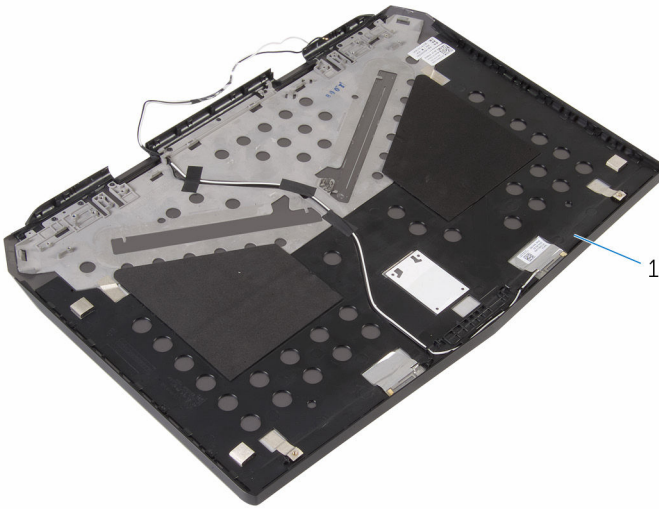

- 1 display back-cover

Replacing the display back-cover



WARNING: Before working inside your computer, read the safety information that shipped with your computer and follow the steps in [Before working inside your computer](#). After working inside your computer, follow the instructions in [After working inside your computer](#). For more safety best practices, see the Regulatory Compliance home page at www.dell.com/regulatory_compliance.

Procedure

- 1 Place the display back-cover on a clean and flat surface.
- 2 Follow the procedure from step 1 to step 3 in "Replacing the [Alienware AlienHead LED board](#)".
- 3 Follow the procedure from step 1 to step 3 in "Replacing the [display-panel AlienFX LEDs](#)".
- 4 Adhere the display board and camera cable to the display back-cover.
- 5 Route the display-board cable through the routing guides on the display back-cover.

Post-requisites

- 1 Replace the [camera](#).
- 2 Replace the [display hinges](#).
- 3 Replace the [display panel](#).
- 4 Follow the procedure from step 2 to step 5 in "Replacing the [display bezel](#)".
- 5 Replace the [display assembly](#).
- 6 Replace the [hinge covers](#).
- 7 Follow the procedure from step 5 to step 11 in "Replacing the [palm rest](#)".
- 8 Replace the [wireless card](#).
- 9 Replace the [solid-state drives](#).
- 10 Replace the [memory modules](#).
- 11 Replace the [base panel](#).

Removing the Alienware AlienHead LED board



WARNING: Before working inside your computer, read the safety information that shipped with your computer and follow the steps in [Before working inside your computer](#). After working inside your computer, follow the instructions in [After working inside your computer](#). For more safety best practices, see the Regulatory Compliance home page at www.dell.com/regulatory_compliance.

Prerequisites

- 1 Remove the [base panel](#).
- 2 Remove the [memory modules](#).
- 3 Remove the [solid-state drives](#).
- 4 Remove the [wireless card](#).
- 5 Follow the procedure from step 1 to step 11 in "Removing the [palm rest](#)".
- 6 Remove the [hinge covers](#).
- 7 Remove the [display assembly](#).
- 8 Follow the procedure from step 1 to step 4 in "Removing the [display bezel](#)".
- 9 Remove the [display panel](#).
- 10 Follow the procedure from step 1 to step 2 in "Removing the [display back-cover](#)".

Procedure

- 1 Peel off the tape that secures the Alienware AlienHead LED board to the display back-cover.

- 2** Note the Alienware AlienHead LED cable routing and peel off the cable from the display back-cover.

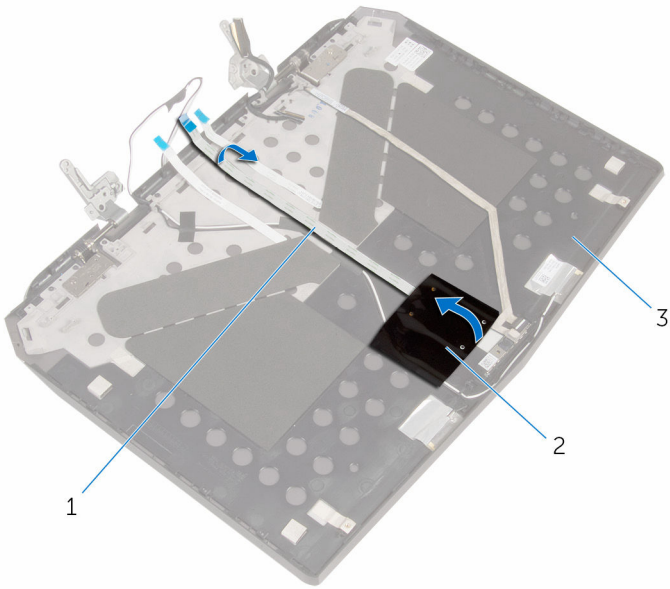

- 1 Alienware AlienHead LED cable 2 tape
- 3 display back-cover

- 3** Note the location of the Alienware AlienHead LED board and peel off the Alienware AlienHead LED board from the display back-cover.

- 4** Lift Alienware AlienHead LED board along with its cable off the display back-cover.

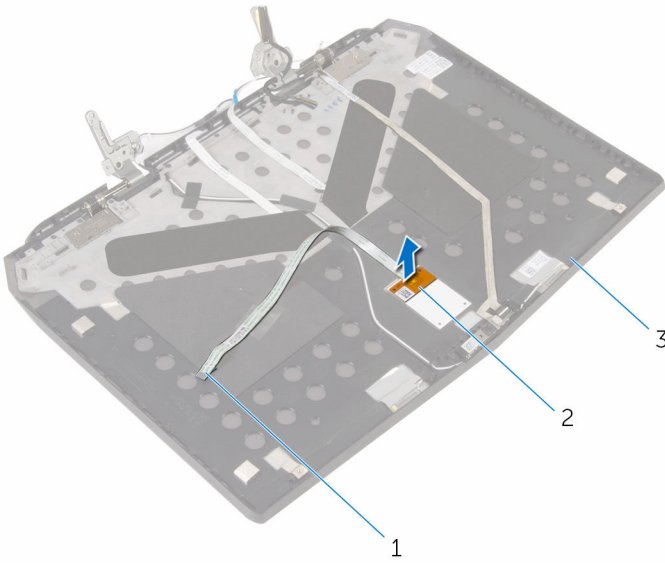

1 Alienware AlienHead LED cable

2 Alienware AlienHead LED board

3 display back-cover

Replacing the Alienware AlienHead LED board

 **WARNING:** Before working inside your computer, read the safety information that shipped with your computer and follow the steps in [Before working inside your computer](#). After working inside your computer, follow the instructions in [After working inside your computer](#). For more safety best practices, see the Regulatory Compliance home page at www.dell.com/regulatory_compliance.

Procedure

- 1 Adhere the Alienware AlienHead LED board to the display back-cover.
- 2 Route the Alienware AlienHead LED cable on the display back-cover and adhere it to the display back-cover.
- 3 Adhere the tape that secures the Alienware AlienHead LED board to the display back-cover.

Post-requisites

- 1 Follow the procedure from step 4 to step 5 in "Replacing the [display back-cover](#)".
- 2 Replace the [display panel](#).
- 3 Follow the procedure from step 2 to step 5 in "Replacing the [display bezel](#)".
- 4 Replace the [display assembly](#).
- 5 Replace the [hinge covers](#).
- 6 Follow the procedure from step 5 to step 11 in "Replacing the [palm rest](#)".
- 7 Replace the [wireless card](#).
- 8 Replace the [solid-state drives](#).
- 9 Replace the [memory modules](#).
- 10 Replace the [base panel](#).

Removing the display-panel AlienFX LEDs



WARNING: Before working inside your computer, read the safety information that shipped with your computer and follow the steps in [Before working inside your computer](#). After working inside your computer, follow the instructions in [After working inside your computer](#). For more safety best practices, see the Regulatory Compliance home page at www.dell.com/regulatory_compliance.

Prerequisites

- 1 Remove the [base panel](#).
- 2 Remove the [memory modules](#).
- 3 Remove the [solid-state drives](#).
- 4 Remove the [wireless card](#).
- 5 Follow the procedure from step 1 to step 11 in "Removing the [palm rest](#)".
- 6 Remove the [hinge covers](#).
- 7 Remove the [display assembly](#).
- 8 Follow the procedure from step 1 to step 4 in "Removing the [display bezel](#)".
- 9 Remove the [display panel](#).
- 10 Follow the procedure from step 1 to step 2 in "Removing the [display back-cover](#)".

Procedure

- 1 Peel off the tapes that secure the display-panel AlienFX LEDs to the display back-cover.

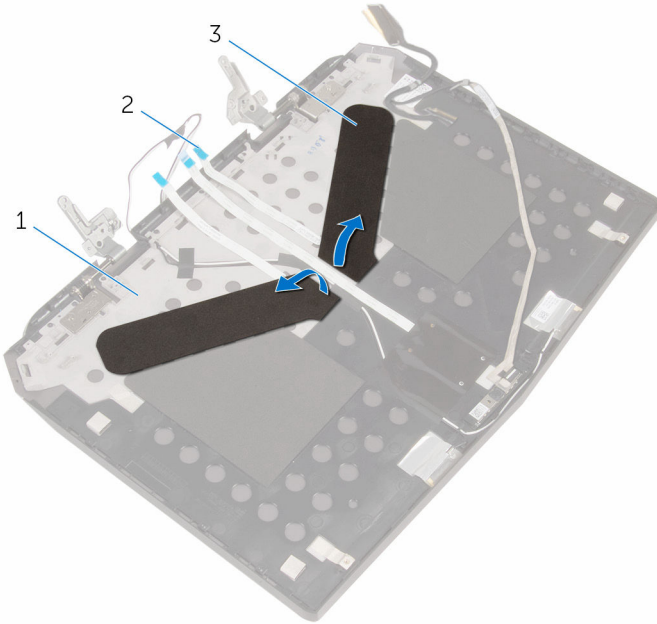

1 display back-cover

2 display-panel AlienFX LED cables (2)

3 tapes (2)

- 2 Note the routing of the display-panel AlienFX LED cables and peel off the cables from the display back-cover.
- 3 Note the location of the display-panel AlienFX LEDs and peel off the LEDs from the display back-cover.

- 4** Lift the display-panel AlienFX LEDs along with the cables off the display back-cover.

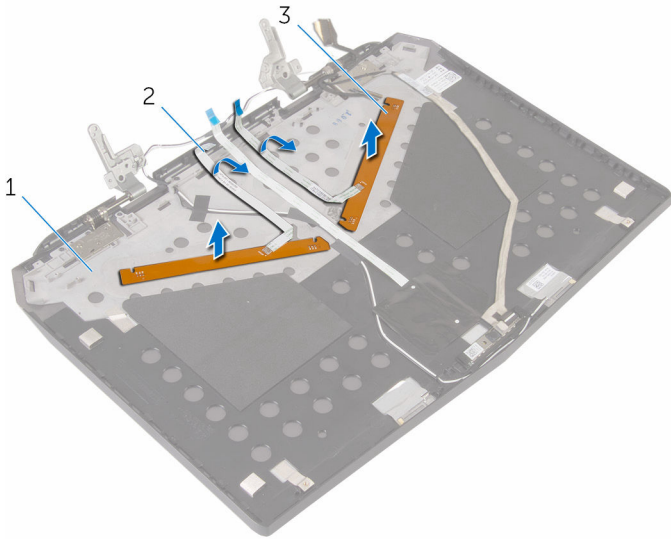

1 display back-cover

2 display-panel AlienFX LED cables (2)

3 display-panel AlienFX LEDs (2)

Replacing the display-panel AlienFX LEDs



WARNING: Before working inside your computer, read the safety information that shipped with your computer and follow the steps in [Before working inside your computer](#). After working inside your computer, follow the instructions in [After working inside your computer](#). For more safety best practices, see the Regulatory Compliance home page at www.dell.com/regulatory_compliance.

Procedure

- 1 Adhere the display-panel AlienFX LEDs to the display back-cover.
- 2 Route the display-panel AlienFX LED cables on the display back-cover and adhere the cables to the display back-cover.
- 3 Adhere the tapes that secure the display-panel AlienFX LEDs to the display back-cover.

Post-requisites

- 1 Follow the procedure from step 4 to step 5 in "Replacing the [display back-cover](#)".
- 2 Replace the [display panel](#).
- 3 Follow the procedure from step 2 to step 5 in "Replacing the [display bezel](#)".
- 4 Replace the [display assembly](#).
- 5 Replace the [hinge covers](#).
- 6 Follow the procedure from step 5 to step 11 in "Replacing the [palm rest](#)".
- 7 Replace the [wireless card](#).
- 8 Replace the [solid-state drives](#).
- 9 Replace the [memory modules](#).
- 10 Replace the [base panel](#).

Removing the logo board



WARNING: Before working inside your computer, read the safety information that shipped with your computer and follow the steps in [Before working inside your computer](#). After working inside your computer, follow the instructions in [After working inside your computer](#). For more safety best practices, see the Regulatory Compliance home page at www.dell.com/regulatory_compliance.

Prerequisites

- 1 Remove the [base panel](#).
- 2 Remove the [memory modules](#).
- 3 Remove the [solid-state drives](#).
- 4 Remove the [wireless card](#).
- 5 Follow the procedure from step 1 to step 11 in “Removing the [palm rest](#)”.
- 6 Remove the [hinge covers](#).
- 7 Remove the [display assembly](#).
- 8 Follow the procedure from step 1 to step 4 in “Removing the [display bezel](#)”.

Procedure

- 1 Turn the display bezel over and place it on a clean and flat surface.

- 2** Note the location of the logo board and pry the logo board off the display bezel using a plastic scribe.

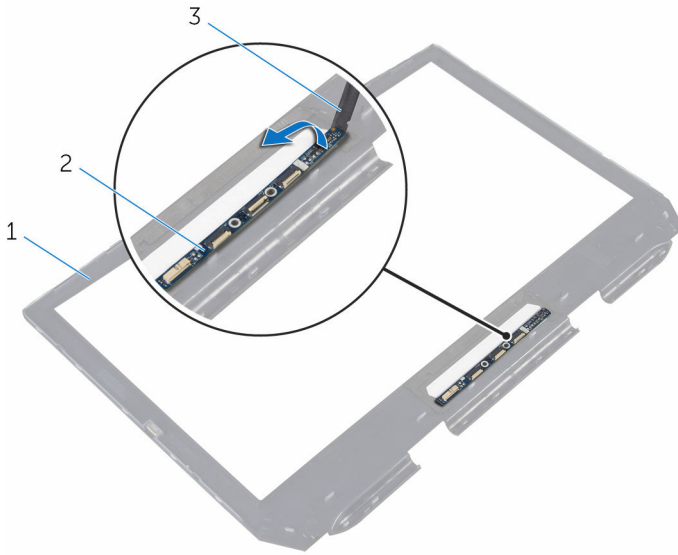

1 display bezel

2 logo board

3 plastic scribe

Replacing the logo board



WARNING: Before working inside your computer, read the safety information that shipped with your computer and follow the steps in [Before working inside your computer](#). After working inside your computer, follow the instructions in [After working inside your computer](#). For more safety best practices, see the Regulatory Compliance home page at www.dell.com/regulatory_compliance.

Procedure

- 1 Adhere the logo board to the display bezel.
- 2 Turn the display bezel over.

Post-requisites

- 1 Follow the procedure from step 2 to step 5 in “Replacing the [display bezel](#)”.
- 2 Replace the [display assembly](#).
- 3 Replace the [hinge covers](#).
- 4 Follow the procedure from step 5 to step 11 in “Replacing the [palm rest](#)”.
- 5 Replace the [wireless card](#).
- 6 Replace the [solid-state drives](#).
- 7 Replace the [memory modules](#).
- 8 Replace the [base panel](#).

Removing the system board

 **WARNING:** Before working inside your computer, read the safety information that shipped with your computer and follow the steps in [Before working inside your computer](#). After working inside your computer, follow the instructions in [After working inside your computer](#). For more safety best practices, see the Regulatory Compliance home page at www.dell.com/regulatory_compliance.

 **NOTE:** Your computer's Service Tag is stored in the system board. You must enter the Service Tag in the BIOS setup program after you replace the system board.

 **NOTE:** Replacing the system board removes any changes you have made to the BIOS using the BIOS setup program. You must make the desired changes again after you replace the system board.

 **NOTE:** Before disconnecting the cables from the system board, note the location of the connectors so that you can reconnect the cables correctly after you replace the system board.

Prerequisites

- 1 Remove the [base panel](#).
- 2 Remove the [memory modules](#).
- 3 Remove the [solid-state drives](#).
- 4 Remove the [wireless card](#).
- 5 Follow the procedure from step 1 to step 11 in "Removing the [palm rest](#)".
- 6 Remove the [hinge covers](#).
- 7 Remove the [display assembly](#).

Procedure

- 1 Turn the computer over.
- 2 Disconnect the fan cables and power-adaptor port cable from the system board.

- 3** Using the pull tab, disconnect the hard-drive cable from the system board.

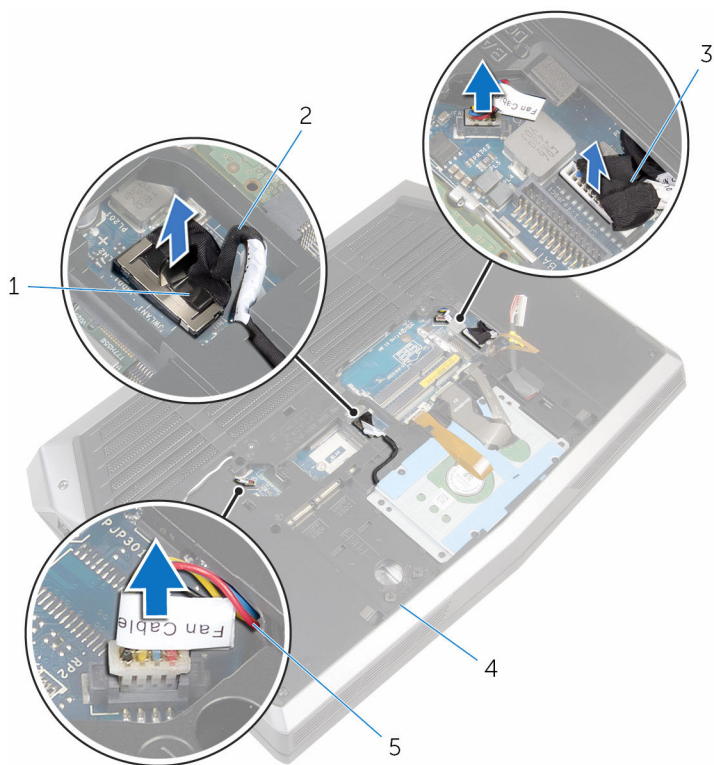

- | | | | |
|---|--------------------------|---|------------------|
| 1 | pull tab | 2 | hard-drive cable |
| 3 | power-adaptor port cable | 4 | computer base |
| 5 | fan cables (2) | | |

- 4** Turn the computer over.
- 5** Lift the latch and disconnect the I/O-board cable from the system board.
- 6** Disconnect the speaker cable from the system board.

- 7** Peel the tape and disconnect the front AlienFX LED cable from the system board.

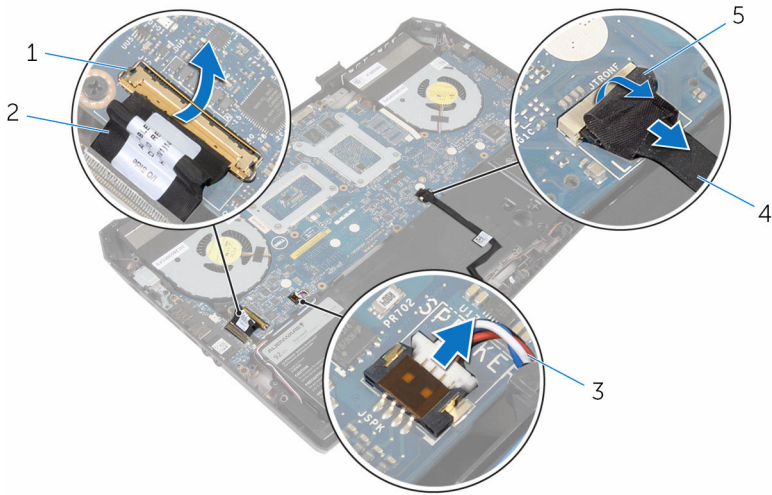

- | | | | |
|---|---------------|---|-------------------------|
| 1 | latch | 2 | I/O-board cable |
| 3 | speaker cable | 4 | front AlienFX LED cable |
| 5 | tape | | |

- 8** Remove the screws that secure the system board to the computer base.
- 9** Lift the system board at an angle and slide the ports on the system board out of the slots on the computer base.

10 Lift the system board off the computer base.

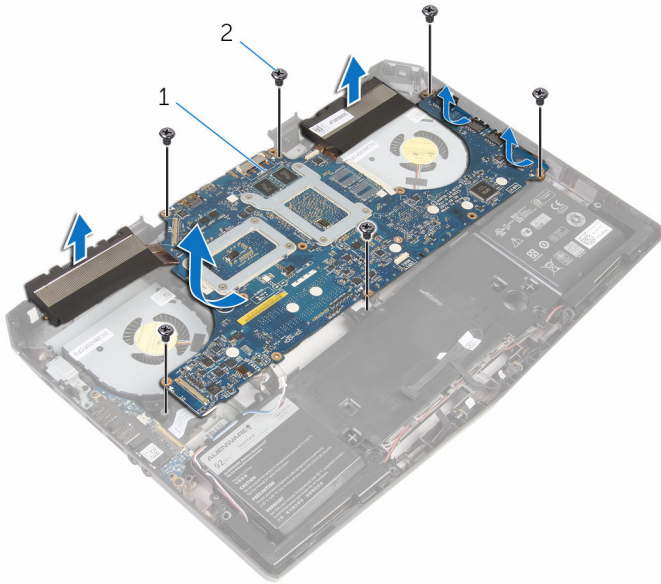

1 system board

2 screws (6)

11 Turn the system board over.

12 Follow the procedure from step 1 to step 2 in "Removing the [heat-sink assembly](#)".

13 Follow the procedure from step 1 to step 2 in "Removing the [coin-cell battery](#)".

Replacing the system board

 **WARNING:** Before working inside your computer, read the safety information that shipped with your computer and follow the steps in [Before working inside your computer](#). After working inside your computer, follow the instructions in [After working inside your computer](#). For more safety best practices, see the Regulatory Compliance home page at www.dell.com/regulatory_compliance.

 **NOTE:** Your computer's Service Tag is stored in the system board. You must enter the Service Tag in the BIOS setup program after you replace the system board.

 **NOTE:** Replacing the system board removes any changes you have made to the BIOS using the BIOS setup program. You must make the desired changes again after you replace the system board.

Procedure

- 1 Follow the procedure from step 1 to step 2 in "Replacing the [coin-cell battery](#)".
- 2 Follow the procedure from step 1 to step 2 in "Replacing the [heat-sink assembly](#)".
- 3 Turn the system board over.
- 4 Slide the ports on the system board into the slots on the computer base and align the screw holes on the system board with the screw holes on the computer base.

 **CAUTION:** Make sure that no cables are under the system board.

- 5 Replace the screws that secure the system board to the computer base.
- 6 Slide the I/O-board cable into the system board and press down on the latch to secure the cable.
- 7 Connect the speaker cable to the system board.
- 8 Connect the front AlienFX LED cable to the system board and secure it with the tape.
- 9 Turn the computer over.
- 10 Connect the fan cables, power-adapter port cable, and hard-drive cable to the system board.

- 11 Turn the computer over.



Post-requisites

- 1 Replace the [display assembly](#).
- 2 Replace the [hinge covers](#).
- 3 Follow the procedure from step 5 to step 11 in "Replacing the [palm rest](#)".
- 4 Replace the [wireless card](#).
- 5 Replace the [solid-state drives](#).
- 6 Replace the [memory modules](#).
- 7 Replace the [base panel](#).

Entering the Service Tag in the BIOS setup program

- 1 Turn on the computer.
- 2 Press F2 when the DELL logo is displayed to enter the BIOS setup program.
- 3 Navigate to the **Main** tab and enter the Service Tag in the **Service Tag Input** field.

Removing the heat-sink assembly

-  **WARNING:** Before working inside your computer, read the safety information that shipped with your computer and follow the steps in [Before working inside your computer](#). After working inside your computer, follow the instructions in [After working inside your computer](#). For more safety best practices, see the Regulatory Compliance home page at www.dell.com/regulatory_compliance.
-  **WARNING:** The heat sink may become hot during normal operation. Allow sufficient time for the heat sink to cool before you touch it.
-  **CAUTION:** For maximum cooling of the processor, do not touch the heat transfer areas on the heat sink. The oils in your skin can reduce the heat transfer capability of the thermal grease.

Prerequisites

- 1 Remove the [base panel](#).
- 2 Remove the [memory modules](#).
- 3 Remove the [solid-state drives](#).
- 4 Remove the [wireless card](#).
- 5 Follow the procedure from step 1 to step 11 in “Removing the [palm rest](#)”.
- 6 Remove the [hinge covers](#).
- 7 Remove the [display assembly](#).
- 8 Follow the procedure from step 1 to step 11 in “Removing the [system board](#)”.

Procedure

- 1 In sequential order (as indicated on the heat-sink assembly), loosen the captive screws that secure the heat-sink assembly to the system board.

2 Lift the heat-sink assembly off the system board.

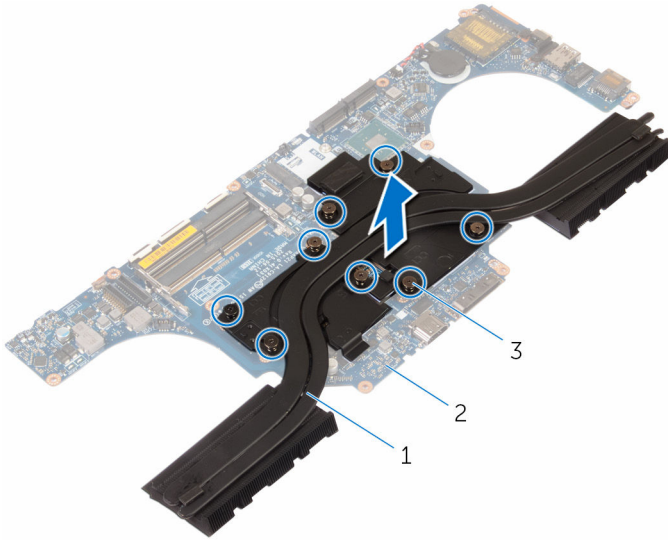

1 heat-sink assembly

2 system board

3 captive screws (8)

Replacing the heat-sink assembly

 **WARNING:** Before working inside your computer, read the safety information that shipped with your computer and follow the steps in [Before working inside your computer](#). After working inside your computer, follow the instructions in [After working inside your computer](#). For more safety best practices, see the Regulatory Compliance home page at www.dell.com/regulatory_compliance.

 **CAUTION:** Incorrect alignment of the heat sink can damage the system board and processor.

 **NOTE:** The original thermal grease can be reused if the original system board and fan are reinstalled together. If either the system board or the fan is replaced, use the thermal pad provided in the kit to ensure that thermal conductivity is achieved.

Procedure

- 1 Align the screw holes on the heat-sink assembly with the screw holes on the system board.
- 2 In sequential order (indicated on the heat-sink assembly), tighten the captive screws that secure the heat-sink assembly to the system board.

Post-requisites

- 1 Follow the procedure from step 3 to step 11 in "Replacing the [system board](#)".
- 2 Replace the [display assembly](#).
- 3 Replace the [hinge covers](#).
- 4 Follow the procedure from step 5 to step 11 in "Replacing the [palm rest](#)".
- 5 Replace the [wireless card](#).
- 6 Replace the [solid-state drives](#).
- 7 Replace the [memory modules](#).
- 8 Replace the [base panel](#).

Removing the fans



WARNING: Before working inside your computer, read the safety information that shipped with your computer and follow the steps in [Before working inside your computer](#). After working inside your computer, follow the instructions in [After working inside your computer](#). For more safety best practices, see the Regulatory Compliance home page at www.dell.com/regulatory_compliance.

Prerequisites

- 1 Remove the [base panel](#).
- 2 Remove the [memory module](#).
- 3 Remove the [solid-state drives](#).
- 4 Remove the [wireless card](#).
- 5 Follow the procedure from step 1 to step 11 in “Removing the [palm rest](#)”.
- 6 Remove the [hinge covers](#).
- 7 Remove the [display assembly](#).
- 8 Follow the procedure from step 1 to step 10 in “Removing the [system board](#)”.

Procedure

- 1 Remove the screws that secure the processor fan and video-card fan to the computer base.

2 Lift the processor fan and video-card fan off the computer base.

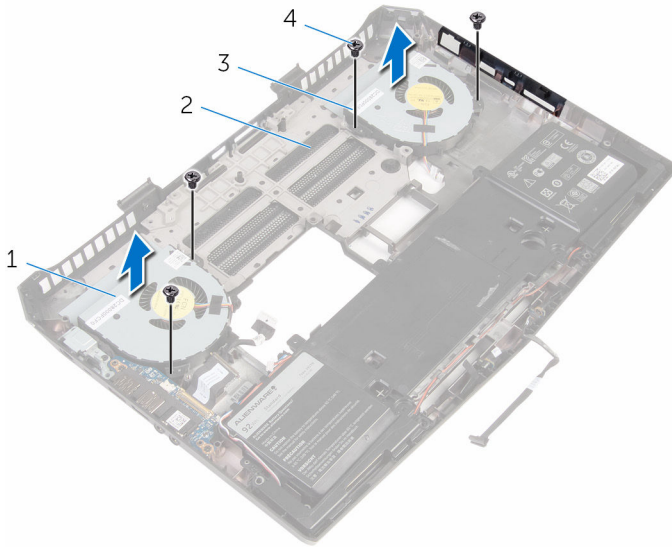

1 processor fan

2 computer base

3 video-card fan

4 screws (4)

Replacing the fans



WARNING: Before working inside your computer, read the safety information that shipped with your computer and follow the steps in [Before working inside your computer](#). After working inside your computer, follow the instructions in [After working inside your computer](#). For more safety best practices, see the Regulatory Compliance home page at www.dell.com/regulatory_compliance.

Procedure

- 1 Align the screw holes on the processor fan and video-card fan with the screw holes on the computer base.
- 2 Replace screws that secure the processor fan and video-card fan to the computer base.

Post-requisites

- 1 Follow the procedure from step 4 to step 11 in "Replacing the [system board](#)".
- 2 Replace the [display assembly](#).
- 3 Replace the [hinge covers](#).
- 4 Follow the procedure from step 5 to step 11 in "Replacing the [palm rest](#)".
- 5 Replace the [wireless card](#).
- 6 Replace the [solid-state drives](#).
- 7 Replace the [memory module](#).
- 8 Replace the [base panel](#).

Removing the power-adapter port



WARNING: Before working inside your computer, read the safety information that shipped with your computer and follow the steps in [Before working inside your computer](#). After working inside your computer, follow the instructions in [After working inside your computer](#). For more safety best practices, see the Regulatory Compliance home page at www.dell.com/regulatory_compliance.

Prerequisites

- 1 Remove the [base panel](#).
- 2 Remove the [memory modules](#).
- 3 Remove the [solid-state drives](#).
- 4 Remove the [wireless card](#).
- 5 Follow the procedure from step 1 to step 11 in “Removing the [palm rest](#)”.
- 6 Remove the [hinge covers](#).
- 7 Remove the [I/O board](#).
- 8 Remove the [display assembly](#).
- 9 Follow the procedure from step 1 to step 10 in “Removing the [system board](#)”.

Procedure

- 1 Remove the screws that secure the power-adapter port bracket to the computer base.
- 2 Lift the power-adapter port bracket off the power-adapter port.
- 3 Note the power-adapter port cable routing and remove the cable from the routing guides on the computer base.

4 Lift the power-adapter port along with its cable off the computer base.

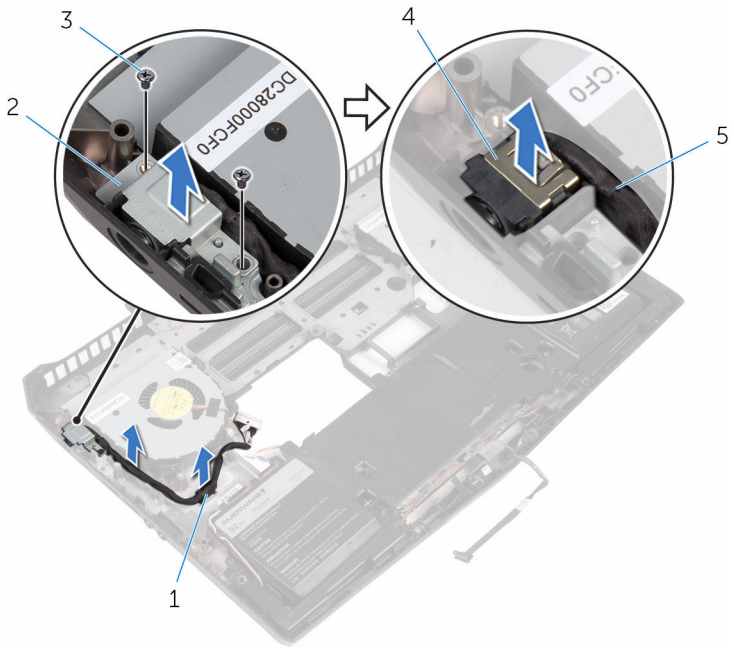

1 routing guide

2 power-adapter port bracket

3 screws (2)

4 power-adapter port

5 power-adapter port cable

Replacing the power-adapter port

 **WARNING:** Before working inside your computer, read the safety information that shipped with your computer and follow the steps in [Before working inside your computer](#). After working inside your computer, follow the instructions in [After working inside your computer](#). For more safety best practices, see the Regulatory Compliance home page at www.dell.com/regulatory_compliance.

Procedure

- 1 Slide the power-adapter port into the slot on the computer base.
- 2 Align the screw holes on the power-adapter port bracket with the screw holes on the power-adapter port.
- 3 Replace the screws that secure the power-adapter port bracket to the computer base.
- 4 Route the power-adapter port cable through the routing guides on the computer base.

Post-requisites

- 1 Follow the procedure from step 4 to step 11 in "Replacing the [system board](#)".
- 2 Replace the [display assembly](#).
- 3 Replace the [I/O board](#).
- 4 Replace the [hinge covers](#).
- 5 Follow the procedure from step 5 to step 11 in "Replacing the [palm rest](#)".
- 6 Replace the [wireless card](#).
- 7 Replace the [solid-state drives](#).
- 8 Replace the [memory modules](#).
- 9 Replace the [base panel](#).

Removing the coin-cell battery

 **WARNING:** Before working inside your computer, read the safety information that shipped with your computer and follow the steps in [Before working inside your computer](#). After working inside your computer, follow the instructions in [After working inside your computer](#). For more safety best practices, see the Regulatory Compliance home page at www.dell.com/regulatory_compliance.

 **CAUTION:** Removing the coin-cell battery resets the BIOS setup program's settings to default. It is recommended that you note the BIOS setup program's settings before removing the coin-cell battery.

Prerequisites

- 1 Remove the [base panel](#).
- 2 Remove the [memory modules](#).
- 3 Remove the [solid-state drives](#).
- 4 Remove the [wireless card](#).
- 5 Follow the procedure from step 1 to step 11 in "Removing the [palm rest](#)".
- 6 Remove the [hinge covers](#).
- 7 Remove the [display assembly](#).
- 8 Follow the procedure from step 1 to step 11 in "Removing the [system board](#)".

Procedure

- 1 Disconnect the coin-cell battery cable from the system board.

- 2** Using a plastic scribe, gently pry out the coin-cell battery from the system board.

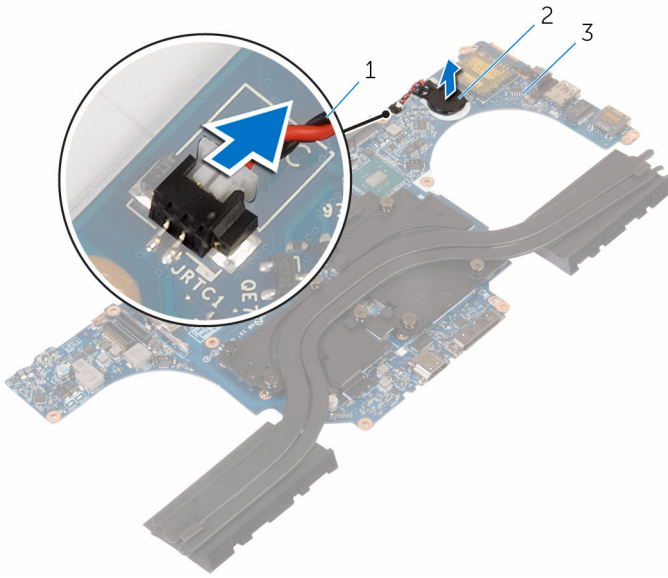

1 coin-cell battery cable

2 coin-cell battery

3 system board

Replacing the coin-cell battery

 **WARNING:** Before working inside your computer, read the safety information that shipped with your computer and follow the steps in [Before working inside your computer](#). After working inside your computer, follow the instructions in [After working inside your computer](#). For more safety best practices, see the Regulatory Compliance home page at www.dell.com/regulatory_compliance.

Procedure

- 1 Adhere the coin-cell battery to the system board.
- 2 Connect the coin-cell battery cable to the system board.

Post-requisites

- 1 Follow the procedure from step 3 to step 11 in "Replacing the [system board](#)".
- 2 Replace the [display assembly](#).
- 3 Replace the [hinge covers](#).
- 4 Follow the procedure from step 5 to step 11 in "Replacing the [palm rest](#)".
- 5 Replace the [wireless card](#).
- 6 Replace the [solid-state drives](#).
- 7 Replace the [memory modules](#).
- 8 Replace the [base panel](#).

Removing the battery



WARNING: Before working inside your computer, read the safety information that shipped with your computer and follow the steps in [Before working inside your computer](#). After working inside your computer, follow the instructions in [After working inside your computer](#). For more safety best practices, see the Regulatory Compliance home page at www.dell.com/regulatory_compliance.

Prerequisites

- 1 Remove the [base panel](#).
- 2 Remove the [memory modules](#).
- 3 Remove the [solid-state drives](#).
- 4 Remove the [wireless card](#).
- 5 Follow the procedure from step 1 to step 11 in "Removing the [palm rest](#)".
- 6 Remove the [hinge covers](#).
- 7 Remove the [display assembly](#).
- 8 Follow the procedure from step 1 to step 10 in "Removing the [system board](#)".

Procedure

- 1 Remove the speaker cable from the routing guides on the battery.

- 2** Note the front AlienFX LED cable routing and peel off the cable from the battery.

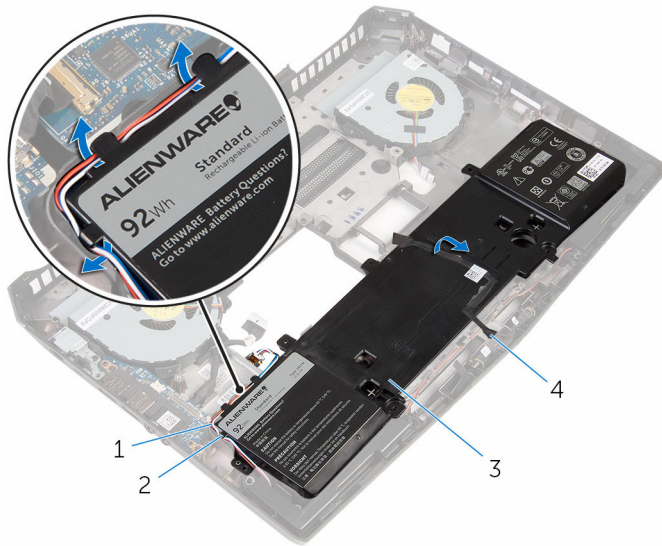

- | | | | |
|---|---------------|---|-------------------------|
| 1 | speaker cable | 2 | routing guides (3) |
| 3 | battery | 4 | front AlienFX LED cable |

- 3** Remove the screws that secure the battery to the computer base.

4 Lift the battery off the computer base.

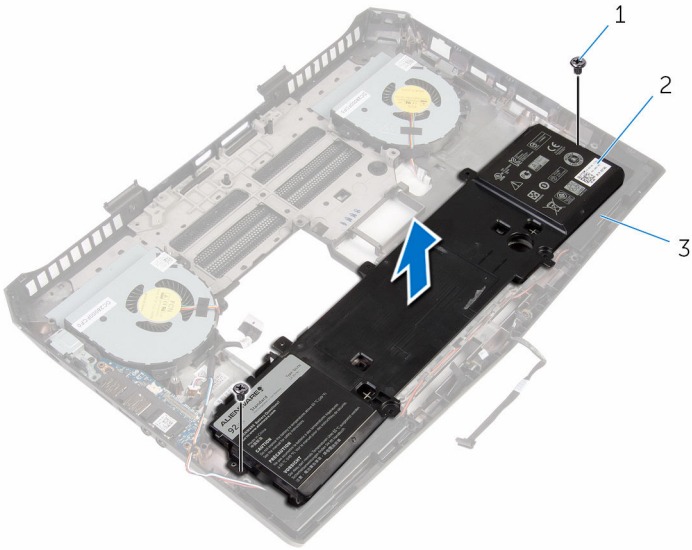

1 screws (2)

2 battery

3 computer base

Replacing the battery



WARNING: Before working inside your computer, read the safety information that shipped with your computer and follow the steps in [Before working inside your computer](#). After working inside your computer, follow the instructions in [After working inside your computer](#). For more safety best practices, see the Regulatory Compliance home page at www.dell.com/regulatory_compliance.

Procedure

- 1 Align the screw holes on the battery with the screw holes on the computer base.
- 2 Replace the screws that secure the battery to the computer base.
- 3 Adhere the front AlienFX LED cable to the battery.
- 4 Route the speaker cable through the routing guides on the battery.

Post-requisites

- 1 Follow the procedure from step 4 to step 11 in "Replacing the [system board](#)".
- 2 Replace the [display assembly](#).
- 3 Replace the [hinge covers](#).
- 4 Follow the procedure from step 5 to step 11 in "Replacing the [palm rest](#)".
- 5 Replace the [wireless card](#).
- 6 Replace the [solid-state drives](#).
- 7 Replace the [memory modules](#).
- 8 Replace the [base panel](#).

Removing the computer base



WARNING: Before working inside your computer, read the safety information that shipped with your computer and follow the steps in [Before working inside your computer](#). After working inside your computer, follow the instructions in [After working inside your computer](#). For more safety best practices, see the Regulatory Compliance home page at www.dell.com/regulatory_compliance.

Prerequisites

- 1 Remove the [base panel](#).
- 2 Remove the [memory modules](#).
- 3 Remove the [solid-state drives](#).
- 4 Follow the procedure from step 1 to step 5 in "Removing the [hard drive](#)".
- 5 Remove the [wireless card](#).
- 6 Remove the [I/O board](#).
- 7 Follow the procedure from step 1 to step 11 in "Removing the [palm rest](#)".
- 8 Remove the [hinge covers](#).
- 9 Remove the [speakers](#).
- 10 Remove the [front AlienFX LED boards](#).
- 11 Remove the [display assembly](#).
- 12 Follow the procedure from step 1 to step 10 in "Removing the [system board](#)".
- 13 Remove the [fans](#).
- 14 Remove the [battery](#).
- 15 Remove the [power-adaptor port](#).

Procedure

After performing the prerequisites, we are left with the computer base.

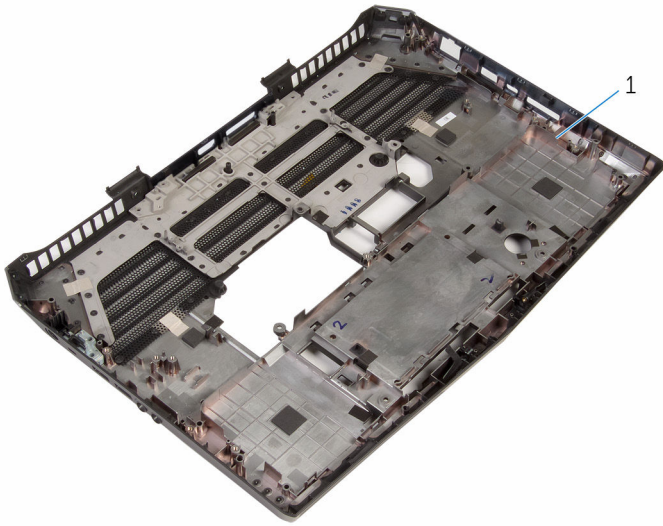

1 computer base

Replacing the computer base

 **WARNING:** Before working inside your computer, read the safety information that shipped with your computer and follow the steps in [Before working inside your computer](#). After working inside your computer, follow the instructions in [After working inside your computer](#). For more safety best practices, see the Regulatory Compliance home page at www.dell.com/regulatory_compliance.

Procedure

Place the computer base on a flat surface.

Post-requisites

- 1 Replace the [power-adaptor port](#).
- 2 Replace the [battery](#).
- 3 Replace the [fans](#).
- 4 Follow the procedure from step 4 to step 11 in "Replacing the [system board](#)".
- 5 Replace the [display assembly](#).
- 6 Replace the [front AlienFX LED board](#).
- 7 Replace the [speakers](#).
- 8 Replace the [hinge covers](#).
- 9 Follow the procedure from step 5 to step 11 in "Replacing the [palm rest](#)".
- 10 Replace the [wireless card](#).
- 11 Replace the [I/O board](#).
- 12 Follow the procedure from step 4 to step 7 in "Replacing the [hard drive](#)".
- 13 Replace the [solid-state drives](#).
- 14 Replace the [memory modules](#).
- 15 Replace the [base panel](#).

BIOS setup program

Overview

 **CAUTION:** Unless you are an expert computer user, do not change the settings in the BIOS setup program. Certain changes can make your computer work incorrectly.

 **NOTE:** Before you change BIOS setup program, it is recommended that you write down the BIOS setup program screen information for future reference.

Use BIOS setup program to:

- Get information about the hardware installed in your computer, such as the amount of RAM, the size of the hard drive, and so on.
- Change the system configuration information.
- Set or change a user-selectable option, such as the user password, type of hard drive installed, enabling or disabling base devices, and so on.

BIOS setup program options

 **NOTE:** Depending on your computer and its installed devices, the items listed in this section may or may not appear.

Main

System Time	Displays the current time in hh:mm:ss format.
System Date	Displays the current date in mm/dd/yyyy format.
BIOS Version	Displays the BIOS version.
Product Name	Displays the model number of your computer.
Service Tag	Displays the service tag of your computer.
Asset Tag	Displays the asset tag of your computer.
CPU Type	Displays the processor type.
CPU Speed	Displays the processor speed.

Main

CPU ID	Displays the processor identification code.
CPU L1 Cache	Displays the processor L1 cache size.
CPU L2 Cache	Displays the processor L2 cache size.
CPU L3 Cache	Displays the processor L3 cache size.
Integrated Graphics	Displays the integrated graphics.
Discrete Graphics 1	Displays the first discrete graphics installed on your computer.
Fixed HDD	Displays the type of hard drive installed.
Second HDD	Displays the type of secondary hard-drive installed.
AC Adapter Type	Displays the type of AC adapter connected to your computer.
System Memory	Displays the system memory.
Extended Memory	Displays the extended memory.
Memory Speed	Displays the memory speed.

Advanced

Intel(R) SpeedStep Technology	<p>Allows you to enable or disable Intel (R) Speedstep Technology.</p> <p> NOTE: If enabled, the processor clock speed and core voltage are adjusted dynamically based on the processor load.</p> <p>Default: Enabled</p>
Virtualization	<p>Allows you to enable or disable the Intel Virtualization technology.</p> <p>Default: Enabled</p>
Integrated NIC	<p>Allows you to enable or disable the on-board LAN controller. Default: Enabled</p>
USB Emulation	<p>Allows you to enable or disable the USB emulation feature. This feature</p>

Advanced

defines how the BIOS, in the absence of a USB-aware operating system, handles USB devices. USB emulation is always enabled during POST.



NOTE: You cannot boot any type of USB device (floppy, hard drive, or memory key) when this option is off.

Default: Enabled

USB PowerShare

Allows you to charge USB devices when the computer is turned off or in standby mode. Default: Enabled

USB Wake Support

Allows you to enable USB devices to wake the computer from standby or to disable the USB wake support feature.



NOTE: If USB PowerShare is enabled, a device connected to the USB PowerShare connector may not wake the computer.

Default: Disabled

SATA Operation

Allows you to configure the operating mode of the integrated SATA hard drive controller. Default: AHCI

Adapter Warnings

Allows you to choose if the computer should display warning messages when you use AC adapters that are not supported by your computer. Default: Enabled

Function Key Behavior

Allows you to set function key or multimedia key as the default function key behavior. Default: Function key

Express Charge

Allows you to charge your computer battery using Standard Charge or Express Charge mode. Default: Express Charge

Advanced

Battery Health	Displays the battery health.
External USB Ports	Allows you to disable or enable the external USB ports. Default: Enabled
USB debug	Allows you to enable or disable this port for Windows debugging. Default: Disabled

Advanced-Performance options

Overclocking Feature	Allows you to enable or disable global overclocking feature. Default: Disabled
----------------------	--

Security

Unlock Setup Status	Displays if the setup status is unlocked.
Admin Password Status	Displays if the administrator password is clear or set. Default: Not set
System password Status	Displays if the system password is clear or set. Default: Not set
HDD password Status	Displays if the HDD password is clear or set. Default: Not set
Service Tag	Displays the service tag of the computer when the service tag is present. Displays a field to input the service tag manually when the service tag is absent.
Admin Password	Allows you to set the administrator password. The administrator password controls access to the system setup utility.
System Password	Allows you to set the system password. The system password controls access to the computer at boot.
HDD password	Allows you to set, change or delete the hard-disk drive password.

Security

Password Change	Allows you to permit or deny system password or HDD password changes. Default: Permitted
-----------------	--

Exit

Save Changes and Reset	Allows you to exit system setup and save your changes.
Discard Changes and Reset	Allows you to exit system setup and load previous values for all system setup options.
Restore Defaults	Allows you to restore default values for all system setup options.
Discard Changes	Allows you to load previous values for all system setup options.
Save Changes	Allows you to save the changes for all system setup options.

Boot sequence

This feature allows you to change the sequence of devices that your computer attempts to boot from. If the computer cannot boot from the device you select, it attempts to boot from the next bootable device. You can use this feature to change the:

- **Current Boot Sequence** — change the boot sequence for the current boot, for example, to boot from the optical drive to run Alienware Diagnostics from the Drivers and Utilities disc or to reinstall your operating system using an external media. The previous boot sequence is restored at the next boot.
- **Future Boot Sequence** — change the boot sequence for all future boots, for example, to boot from the primary hard drive.

Boot options



NOTE: The following boot options are available only when the Boot List Option is set to Legacy.

Floppy (Diskette Drive) — The computer attempts to boot from the floppy disk drive. If no operating system is on the drive, the computer generates an error message.

Hard Drive — The computer attempts to boot from the primary hard drive. If no operating system is on the drive, the computer generates an error message.

CD/DVD/CD-RW Drive — The computer attempts to boot from the optical drive. If no disc is in the drive, or if the disc is not bootable, the computer generates an error message.

USB Storage Device — Insert the memory device into a USB connector and restart the computer. When **F12 Boot Options** appear in the lower-right corner of the screen, press F12. The BIOS detects the device and adds the USB flash option to the boot menu.

 **NOTE:** To boot to a USB device, the device must be bootable. To ensure that your device is bootable, check the device documentation.

Network — The computer attempts to boot from the network. If no operating system is found on the network, the computer generates an error message.

Changing boot sequence for the current boot

- 1 If you are booting from a USB device, connect the USB device to a USB port.
- 2 Turn on (or restart) your computer.
- 3 When **F2 Setup**, **F12 Boot Options** appear in the lower-right corner of the screen, press F12.

 **NOTE:** If you wait too long and the operating system logo appears, continue to wait until you see the Microsoft Windows desktop. Then, shut down your computer and try again.

The **Boot Options** appears, listing all available boot devices.

- 4 On the **Boot Options**, select the device you want to boot from and press Enter.
For example, if you are booting to a USB hard drive, highlight **USB Hard Disk** and press Enter.

Changing boot sequence for future boots

- 1 Enter BIOS setup program.
See "[Entering BIOS setup program](#)".
- 2 Use the arrow keys to highlight the **Boot** menu option and press Enter to access the menu.
 **NOTE:** Note your current boot sequence in case you want to restore it.
- 3 Navigate to **Set Boot Priority** to configure the boot priority.

- 4** Use the arrow keys to highlight the boot priority and press Enter to display the different devices.
- 5** Select the device and press Enter to set the boot priority.

Flashing the BIOS

You may need to flash (update) the BIOS when an update is available or when you replace the system board. To flash the BIOS:

- 1 Turn on the computer.
- 2 Go to **www.dell.com/support**.
- 3 Click **Product Support**, enter the Service Tag of your computer and click **Submit**.
 -  **NOTE:** If you do not have the Service Tag, use the auto-detect feature or manually browse for your computer model.
- 4 Click **Drivers & downloads**.
- 5 Select the operating system installed on your computer.
- 6 Scroll down the page and expand **BIOS**.
- 7 Click **Download File** to download the latest version of the BIOS for your computer.
- 8 Save the file and, once the download is complete, navigate to the folder where you saved the BIOS update file.
- 9 Double-click the BIOS update file icon and follow the instructions on the screen.

Getting help and contacting Alienware

Self-help resources

You can get information and help on Alienware products and services using these online self-help resources:

Self-Help Information	Self-Help Options
Accessing Windows Help	Windows 10/Windows 8.1 —In Windows search, type Help and Support , and press Enter . Windows 7 —Click Start → Help and Support .
Learn about Windows	Launch the: <ul style="list-style-type: none">• Dell Help & Support app (Windows 10/Windows 8.1)• Get started app (Windows 10)• Help+Tips app (Windows 8.1)
Information about Alienware products and services	www.alienware.com
Troubleshooting information, user manuals, setup instructions, product specifications, technical help blogs, drivers, software updates, and so on	www.alienware.com/gamingservices
Videos providing step-by-step instructions to service your computer	www.youtube.com/alienwareservices

Contacting Alienware

To contact Alienware for sales, technical support, or customer service issues, see **www.alienware.com**.

 **NOTE:** Availability varies by country and product, and some services may not be available in your country.



NOTE: If you do not have an active internet connection, you can find contact information on your purchase invoice, packing slip, bill, or Dell product catalog.